

Issued by
Gigaset Communications GmbH
Schlavenhorst 66, D-46395 Bocholt
Gigaset Communications GmbH is a trademark licensee of Siemens AG

© Gigaset Communications GmbH 2008
All rights reserved.
Subject to availability. Rights of modifications reserved.

www.gigaset.com







SIEMENS

Gigaset

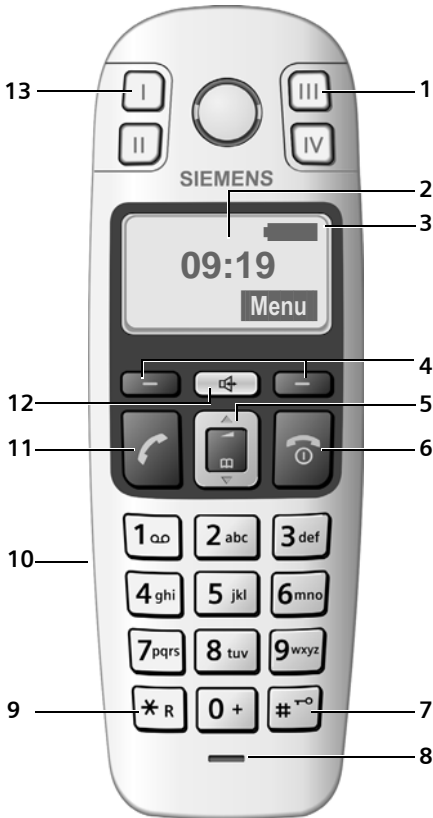
E365

The handset at a glance



- 1 Direct dialling keys (II to IV)
- 2 **Display** in idle status (example)
- 3 **Battery charge level**

 (1/3 charged to fully charged)

 flashes: battery almost flat

 flashes: battery charging
- 4 **Display keys** (page 16)
- 5 **Control key** (page 15)
- 6 **End call key, On/off key**
 End call, cancel function, go back one menu level (press briefly), back to idle status (press and hold), activate/deactivate handset (press and hold in idle status)
- 7 **Hash key**
 Keypad lock on/off (press and hold in idle status, page 15)
 Insert a pause (press and hold for dialling)
 Switch between uppercase/lowercase letters and digits for text entry (page 40)
- 8 **Microphone**
- 9 **Recall key**
 Enter flash (press and hold)
- 10 **Connection socket for headset** (page 41)
- 11 **Talk key**
 Answer a call, start dialling
- 12 **Handsfree key**
 Toggle between earpiece and handsfree mode
 Lights up: handsfree activated
 Flashes: incoming call
- 13 **Direct dialling/SOS key with SOS LED**

Gigaset contact numbers:

For personal advice on our range of products and for repairs or guarantee/warranty claims call:

Service Centre UK: 08453 6708 12
 (local call cost charge)

Please have your proof of purchase ready when calling.

E365 base station at a glance

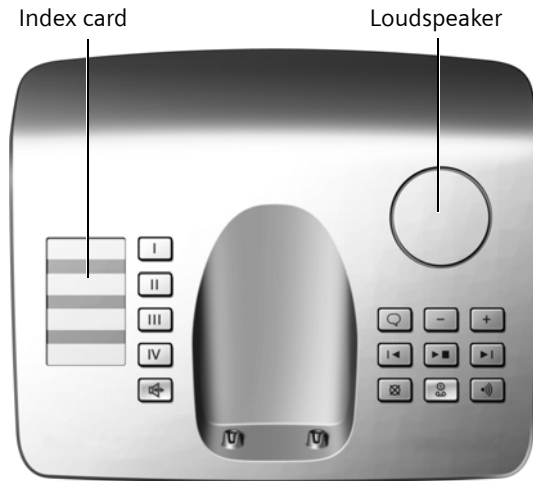

- I** **Direct dialling/SOS key** with SOS LED (see page 18)
- II** ... **IV** **Direct dialling keys** (see page 18)
- [Speaker icon]** **Handsfree key:** answer/end a call
- [Speaker icon]** **Registration/paging key:**
 - Page handsets (press briefly, "Paging", page 31).
 - Register handsets (press and hold, page 30).

Answering machine keys

- [Speaker icon]** **On/off key:** activate and deactivate answering machine.
 - **Lights up:** answering machine is activated.
 - **Flashes:** there is at least one new message or message is in the process of being recorded.
 - **Flickers for about four seconds:** memory is full.
- [Play/Pause icon]** **Playback/Stop key:** Play back messages from the answering machine or cancel playback.
- [Next icon]** **Forward key:** Skip to next message.
- [Previous icon]** **Back key:** Skip to previous message.

- [X icon]** **Delete key:** Delete the current message during message playback or all old messages in idle status.
- [Speech bubble icon]** **Announcement key:** Record, play back and delete a personal announcement.
 - press and **hold:** record announcement. Press again to end recording.
 - press **briefly:** play back announcement.Delete announcement during playback, if required, with **[X icon]**.
- [Minus icon]** **Volume keys:** adjust volume
- [Plus icon]** (**[Minus icon]** = quieter; **[Plus icon]** = louder)
 - **During message playback:** adjust loudspeaker volume.
 - **While an external call is being signalled:** adjust ringtone volume.

Please remember:

- If the answering machine is being operated from a handset or if it is recording a message, it cannot be operated from the base station.
- If the on/off key flashes although the answering machine is switched off, there is still at least one new message on the answering machine that has not been played back yet.

Contents

The handset at a glance	1
E365 base station at a glance ...	2
Safety precautions	5
Special features of the Gigaset E365	6
SOS mode	6
Gigaset E365 – more than just a telephone	8
First steps	8
Pack contents	8
Installing the base station	8
Connecting the base station	8
Setting up the handset for use	9
Menu tree	12
Making calls	14
Making an external call/ ending a call	14
Answering a call	14
Calling line identification	14
Handsfree operation	15
Operating the handset	15
Switching the handset on/off	15
Activating/deactivating the keypad lock	15
Control key on the handset	15
Display keys	16
Returning to idle status	16
Menu guidance	16
Correcting incorrect entries	16
Using the directory, direct dialling keys and lists	17
Directory	17
Direct dialling and SOS keys	18
Last number redial list	20
Opening the message list with the display key	20
Automatic network provider code (preselection)	22
SMS (text messages)	23
Writing/sending an SMS	23
Receiving an SMS	24
Setting up the SMS centre	25
SMS to a PABX	25
Activating/deactivating the SMS function	26
SMS troubleshooting	26
Operating the base station answering machine	27
Operation via the handset	27
Activating/deactivating call screening	29
Setting up the answering machine ...	29
Resetting speed dialling on the answering machine	29
Using the network mailbox ...	30
Using the network mailbox for setting speed dialling	30
Using several handsets	30
Registering handsets	30
Locating a handset ("Paging")	31
Making internal calls	31
Listening in to an external call	32
Handset settings	32
Changing the display language	32
Screensaver	32
Auto answer	32
Adjusting the loudspeaker volume ...	33
Changing ringtones	33
Activating/deactivation suppression of the first ringtone ...	33
Advisory tones	33
Using the handset as an alarm clock .	34
Restoring the handset default settings	34

Contents

Base station settings	34
Changing the system PIN	34
Changing ringtones	35
Restoring the base station to factory settings	35
Operating the base station on the PABX	35
Appendix	36
Symbols and typographical conventions used	36
Care	36
Contact with liquid	36
Questions and answers	36
Service (Customer Care)	37
Authorisation	38
Technical data	38
Guarantee Certificate United Kingdom	39
Writing and editing a text message . .	40
Accessories	41
Wall mounting for base station	41
Index	42

Safety precautions

Caution:

Read the safety precautions and the user guide before use.

Explain their contents to your children as well as the potential hazards associated with using the telephone.



Only use the mains adapter supplied, as indicated on the underside of the base station.



Only fit the **recommended rechargeable batteries** of the same type (page 38)! In other words, do not use any other battery type or non-rechargeable batteries as this could result in significant health risks and personal injury.



Fit rechargeable batteries with the correct polarity and use them according to this user guide (polarity symbols can be seen in the handset's battery compartment, page 9).



The operation of medical appliances may be affected. Be aware of the technical conditions in your particular environment, for example doctor's surgery.



Do not hold the reverse side of the handset to your ear if the handset is ringing or if the handsfree function is switched on. Otherwise, you risk developing serious, permanent hearing damage.

The handset may cause an unpleasant humming noise in hearing aids.



Do not install the base station in bathrooms or shower rooms. The handset and base station are not splash proof (page 36).



Do not use the phone in environments with a potential explosion hazard, for example auto paint shops.



If you give your Gigaset to someone else, make sure you also give them the user guide.



All electrical and electronic products should be disposed of separately from the municipal waste stream via designated collection facilities appointed by the government or the local authorities.

This crossed-out wheeled bin symbol on the product means the product is covered by the European Directive 2002/96/EC.

The correct disposal and separate collection of your old appliance will help prevent potential negative consequences for the environment and human health. It is a precondition for reuse and recycling of used electrical and electronic equipment.

For more detailed information about disposal of your old appliance, please contact your local council refuse centre or the original supplier of the product.

Please note:

Not all of the functions described in this user guide are available in all countries.

Special features of the Gigaset E365

- ◆ Large keys
- ◆ Text and symbols are shown clearly in large type on the display
- ◆ Jumbo Font
- ◆ SOS mode
- ◆ Direct dialling keys
- ◆ Internal calls between handset and base station
- ◆ Voice prompted answering machine
- ◆ Compatibility with hearing aids (HAC – Hearing Aid Compatibility)
- ◆ Connection for headset (headset not included in scope of delivery)
- ◆ Index card for labelling the SOS/direct dialling keys
(reverse side of user guide)

SOS mode

Your Gigaset E365 is equipped with a special **SOS function** or SOS procedure. You can use this SOS procedure to request assistance in case of emergency. You can store up to **four SOS numbers**.

The SOS numbers can be stored on the **SOS/direct dialling key I**. In case of an emergency, you then only have to press the **direct dialling key I**. The SOS procedure is initiated when you press this key.

The SOS procedure automatically dials the first SOS number you entered. If this number is busy or if the person called is not at home, the SOS procedure automatically dials the next SOS number.

In order to use the SOS procedure, you have to first program the **SOS/direct dialling key I** and activate **SOS mode** (page 18).



When SOS mode is activated, the SOS LED lights up permanently in the SOS key on the handset and base station!

SOS procedure

The way the SOS procedure operates is described below.

Press the SOS/direct dialling key **[1]** on the **base station** and the device **dials immediately**.

You have to **press and hold** the SOS/direct dialling key **[1]** on the **handset** to **launch the function immediately**.

If you just press the key briefly and don't hold it down, you have to confirm with **Yes** to prevent an emergency call from being initiated inadvertently.

The first SOS number is dialled as soon as you press the SOS direct dialling key. At the same time, the message "*Sending emergency call*" is played back via the loudspeaker.

If the SOS call is answered, the callee automatically first hears the message "*This is an emergency call*". Your name is then played back after this message. You must have programmed the SOS key accordingly in order for your name to be announced (see page 18). This is followed by the message "*To accept the call please press 5*". If the callee now presses key 5, you can converse with one another.

If the callee does not answer the call, for example because s/he is not at home or his/her answering machine is switched on, the SOS procedure automatically dials the next SOS number. The SOS procedure switches automatically to the next SOS number after 60 seconds in the following cases:

- ◆ The call is not answered
- ◆ The answering machine for the selected SOS number is switched on
- ◆ The SOS number is busy

The procedure is repeated at most four times. If none of the calls is answered, the SOS procedure is ended with an error tone.

Recipients of the emergency call must have set their telephones to tone dialling as otherwise confirmation of the SOS call with key 5 will not be recognized.

i

- During the entire procedure, all SOS keys flash on all registered handsets and on the base station. The message "*Sending emergency call*" is issued on the handset that triggered the emergency call.
- If an internal call is programmed additionally, the SOS call can also be answered by an internal user. The text "*Emergency call*" is output on all registered handsets and the base station.
- You should perform a test run of the SOS procedure to ensure that SOS mode is programmed correctly. The police, rescue services or fire brigade must not be used for a test run.
- Please note that the standby time of the handset will be reduced when SOS mode is activated.
- The SOS LED lights up permanently when SOS mode is activated!

Gigaset E365 – more than just a telephone

Your phone not only enables you to send and receive text messages over the fixed network and store up to 100 telephone numbers (page 17) – it can do a whole lot more:

- ◆ You can programme the direct dialling keys of your phone with important phone numbers. The number is then dialled by simply pressing a key (page 18).
- ◆ Use the handsfree function (page 15) to keep your hands free when making a call.
- ◆ Use your handset as an alarm clock (page 34).

ECO DECT - what does it mean?

- Transmitting power is switched off when the handset is placed in the base station.

The transmitting power of the base station is switched off when only 1 handset is registered on the base station!

Additionally, your Gigaset handset automatically reduces transmitting power depending on the distance to the base station (close-up range).

Have fun using your new telephone!

First steps

Pack contents

The packaging contains a Gigaset E365 base station, a Gigaset E36 handset, a mains adapter, a telephone cable, two batteries, a battery cover, a belt clip and a user guide.

Installing the base station

The base is designed to be operated in enclosed, dry areas at temperatures ranging from +5 °C to +45 °C.

Set up the base station at a central point in the apartment or house.

Please refer to the end of the user guide for information on wall-mounting the base station.

Please remember:

- ◆ Never expose the telephone to heat sources, direct sunlight, other electrical appliances.
- ◆ Protect your Gigaset from moisture, dust, corrosive liquids and vapours.

Connecting the base station

- ▶ **First** connect the mains adapter and **then** the phone jack as shown below and place the phone cord in the cord recess.

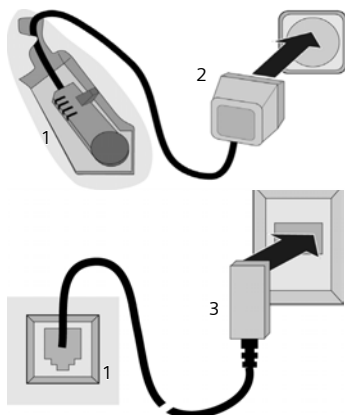

- 1 Underside of the base (section)
- 2 Mains adapter 230 V
- 3 Phone jack with phone cord

Please remember:

- ◆ Keep the mains adapter **plugged in at all times** for operation as the phone does not work without mains connection.
- ◆ If you buy a replacement phone cord from a store ensure that the phone jack is connected correctly.

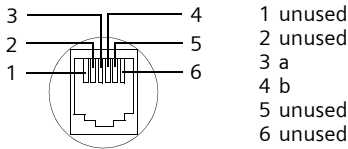
Correct phone jack assignment

Setting up the handset for use

Fitting the batteries and closing the cover

Caution:

Use only the rechargeable batteries recommended by Gigaset Communications GmbH * on page 38. Never use a conventional (non-rechargeable) battery or other battery types as this could result in significant health risks and personal injury. For example, the batteries could explode. The phone could also malfunction or be damaged as a result of using batteries that are not of the recommended type.

* Gigaset Communications GmbH is a trademark licensee of Siemens AG.

- ▶ Fit the batteries with the correct polarity (see diagram).

The polarity is indicated in the battery compartment.

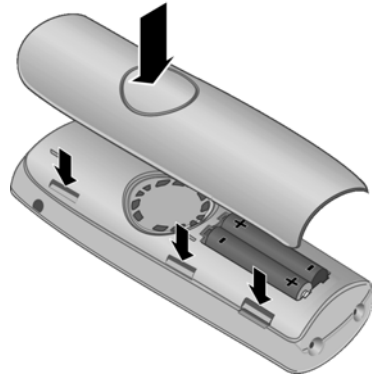

- ▶ First align the notches on the side of the battery cover with the protrusions of the inside of the casing.
- ▶ Then press down the cover so that it clicks into place.

Attaching the belt clip

There are notches on the side of the handset at the same height as the display.

- ▶ Press the belt clip onto the back of the handset so that the protrusions on the belt clip engage with the notches.

You can also attach a cord for carrying the handset in your hand or wearing it around your neck.



Opening the battery cover

- ▶ If fitted, remove the belt clip.
- ▶ Reach into the housing cavity and pull the battery cover upwards.



Placing the handset in the base station and registering

Requirement: the handset must not already be registered on **any** base station.

Registering the handset on the Gigaset E365 base station occurs automatically.

- ▶ Place the handset in the charging cradle of the base station with its **display facing forward**.

You will hear a confirmation tone.

Automatic registration can take up to 5 minutes. While registration is in progress the screen displays **Registering** . The handset is assigned the lowest unassigned internal number (1–4). If several handsets are registered on the base, the internal number is shown in the display after registration, for example 2. This means that the handset has been assigned the internal number 2.

Please note:

- Automatic registration is only possible if the base station on which you wish to register the handset is not being used to make a call.
- A key press cancels automatic registration.
- If four handsets are already registered on the base station there are two options:
 - The handset with the internal number 4 is in idle status: the handset you wish to register is assigned the number 4. The handset that was previously number 4 is de-registered.
 - The handset with the internal number 4 is being used: the handset you wish to register cannot be registered.
- If automatic registration does not work the handset will have to be registered manually (page 30).



- ▶ To charge the batteries, leave the handset in the charging cradle on the base station.

Please note:

- The handset may only be placed in the base/charging cradle provided for it.
- If the handset has switched itself off because the batteries are flat and is then placed in the base/cradle, it will switch itself on automatically.

For questions and problems see page 36.

Initial charging and discharging of batteries

Battery charging is indicated in the top right of the display by a flashing battery icon ,  or . During handset operation, the battery icon indicates the charge status of the batteries (page 1).

The correct charge status can only be displayed when the batteries are first fully charged **and** discharged through use.



- ▶ To do this, leave the handset in the base without interruption until the battery icon stops flashing in the display (approx. 6h).
- ▶ Once the batteries are fully charged, remove the handset from the base and do not put it back again until the batteries are fully discharged.

Please note:

After the first battery charge **and** discharge you may replace your handset in its base after every call.

Please remember:

- ◆ Always repeat the charging and discharging procedure if you remove the batteries from the handset and re-insert them.
- ◆ The batteries may warm up as they are charging. This is not dangerous.
- ◆ After a time the charge capacity of the batteries will decrease for technical reasons.

Please note:

You will find explanations for the symbols and typographical conventions used in this user guide in the appendix, page 36.

Setting the date and time

Menu → Settings → **OK** → Date/Time
→ **OK**



Enter the day, month and year with 6 digits and press **OK**. Use  to move between the fields.



Enter hours and minutes with 4 digits (e.g. 0 7 1 5 for 07.15 hrs) and press **OK**. Use  to move between the fields.

Once the phone is registered and the time set, the idle display looks as shown on page 1.

Your phone is now ready for use.

The answering machine is set with a standard announcement.

Menu tree

There are two ways to select a function:

Using number combinations ("shortcut")

- ▶ To open the main menu, press **Menu** with the handset in idle status.
- ▶ Enter the number combination that is in front of the function in the menu tree.
- ▶ **Example:** **Menu** **6** **3** for "Set handset language".

Scrolling through the menus (see also page 36)

- ▶ To open the main menu, press **Menu** with the handset in idle status.
- ▶ Scroll to the required function with the control key and press **OK**.

1 Directory

2 Calls

3 SMS

3-1	Write Message				
3-2	Incoming 00+00				
3-3	Outgoing				
3-4	Settings	3-4-1	Service Centres	3-4-1-1	Service Centre 1
				...	[to]
				3-4-1-3	Service Centre 3
		3-4-2	Subscribe SMS		

4 Alarm

4-1	Activation
4-2	Wakeup time

5 Audio Settings

5-1	Handset Volume		
5-2	Handsfree Volume		
5-3	Ringer Volume		
5-4	Ringer Melody	5-4-1	External Calls
		5-4-2	Internal Calls
		5-4-3	Alarm Clock
5-5	Advisory Tones		
5-6	Battery Low	5-6-1	Off
		5-6-2	On
		5-6-3	During Call
5-7	Headset Volume		

6 Settings

6-1	Date/Time				
6-2	Direct Diall. Keys				
6-3	Language				
6-4	Jumbo Font				
6-5	Emergency Call Mode				
6-6	Emergency Numbers				
6-7	Handset	6-7-1	Screen Saver		
		6-7-2	Auto Answer		
		6-7-3	Register Handset		
		6-7-4	Reset Handset		
6-8	Base	6-8-1	Audio Settings	6-8-1-1	Loud Speaker
				6-8-1-2	Ringer Volume
				6-8-1-3	Ringer Melody
		6-8-2	System PIN		
		6-8-3	Base Reset		
		6-8-4	Listening in		
		6-8-5	Preselection	6-8-5-1	Preselect Number
				6-8-5-2	With Preselect
				6-8-5-3	Without Preselect



7 Voice Mail



7-1	Set Key 1	7-1-1	Network Mailbox
		7-1-2	Answer Machine
7-2	Answer Machine		
7-3	Call Screening	7-3-1	Handset
		7-3-2	Base
7-4	Announcements	7-4-1	Record Announce.
		7-4-2	Play Announce.
		7-4-3	Delete Announce.
7-5	Message Length	7-5-1	Maximum
		7-5-2	30 sec
		7-5-3	60 sec
		7-5-4	120 sec
7-6	Ring Delay	7-6-1	Immediately
		7-6-2	10 sec
		7-6-3	20 sec
		7-6-4	30 sec
		7-6-5	Auto

Making calls

Making an external call/ ending a call

External calls are calls using the public telephone network.

 (Enter phone number) → .

The number is dialled. (You can also **first** press the  key [ringtone] and then enter the number.) The earpiece volume can be adjusted during the call with the  key.



End a call/cancel dialling:

Press the end call key  or place the handset in the base station or charging cradle.

Answering a call

The handset indicates an incoming call in three ways: by ringing, by a display on the screen and by the flashing handsfree key .

You can answer the call by:

- ▶ Pressing the talk key .
- ▶ Pressing the handsfree key .
- ▶ Press the display key **Accept**.

If the handset is in the base and the **Auto Answer** function is activated (page 32), the handset will answer a call automatically when you lift it out of the base.

If the ringtone is intrusive, press **Silence**. The ringtone is switched off for this call. You can answer the call so long as it is displayed on the screen.

Calling line identification

When you receive a call, the caller's number is displayed on the screen if the following conditions are met:

- ◆ Your network provider supports CLIP, CLI:
 - CLI (calling line identification): the caller's number is transmitted
 - CLIP (calling line identification presentation): the caller's number is displayed
- ◆ You have arranged CLIP with your network provider.
- ◆ The caller has arranged CLI with the network provider.

Displaying the caller's number





The phone number of the caller is shown on the display or also the name of the caller if the name has been stored in the directory.

Requirements:

1. You have arranged with your network provider to have the phone number of the caller (CLIP) shown on your display.
2. The caller has arranged with the network provider to allow his/her phone number to be identified (CLI).

The screen displays **Extern. Call** if you have not arranged for calling line identification presentation, **Withheld** if calling line identification has been withheld by the caller or **Unavailable** if it has not been arranged with the network provider.

Handsfree operation

You can make calls immediately in handsfree mode (the  key lights up permanently) after entering the phone number by pressing the handsfree key . Toggle between earpiece and handsfree mode during a call and when playing back the answering machine by pressing the  key. The volume can be adjusted during handsfree operation with the  key.

Operating the handset

Switching the handset on/off



Press and hold the end call key.

You will hear the confirmation tone.

Activating/deactivating the keypad lock



Press and **hold** the hash key.

You will hear the confirmation tone. The icon  appears in the display when the keypad lock is activated.

Please note:

- The handset displays an advisory message if you press a key by accident while the keypad lock is on. To deactivate the keypad lock, press the hash key  **and hold**.
- The keypad lock does not apply for the SOS key.

Control key on the handset



1 Control key

The side of the control key you have to press in the given operating situation is shown in black (top, bottom) in this user guide. Example:  for "press the top of the control key".

The control key has a number of different functions:

When the handset is in idle status



Open the directory.



Adjust the ringer melody volume of the handset (page 33).

In lists and menus



Scroll up/down line by line.

In an input field



Move the cursor **left** or **right**.

During an external call



Open the directory.



Adjust loudspeaker volume for earpiece and handsfree mode.

Display keys

The current display functions are shown in the bottom display line. The functions of the display keys change depending on the particular operating situation.

Example:

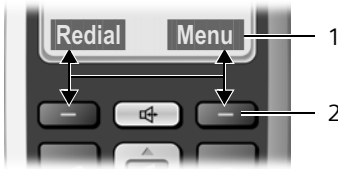

- 1 Current display key functions
- 2 Display keys

The most important display symbols are:

Back	Go back one menu level or cancel operation.
Menu	Open the main menu or a context-dependent menu.
OK	Confirm highlighted selection.
Delete	Delete key: backspace delete one character at a time.
Redial	Open the last number redial list.

Returning to idle status

You want to return to idle status from anywhere in the menu: Press the end call key  and **hold**.

If you do not press any key, the display will **automatically** revert to idle status after 2 minutes.

Changes that you have not confirmed/ stored by pressing **OK** will be rejected.

For an example of the display in idle status: page 1.

Menu guidance

Your telephone's functions are accessed using a menu that has a number of levels.

Main menu (first menu level)

- ▶ To open the main menu, press **Menu** with the handset in idle status.

Accessing a function

- ▶ Scroll to the function with the control key  and press **OK** or enter the digit that appears before the function in the menu overview (page 12).

The corresponding submenu (the next menu level) is opened.

Submenus

The functions in the submenus are displayed as lists.

To access a function:

- ▶ Scroll to the function with the control key  and press **OK** or enter the digit combination that appears before the function in the menu overview (page 12).

Briefly pressing the end call key  returns you to the previous menu level / cancels the operation.

Correcting incorrect entries

- ◆ Navigate to the wrong input with the control key if  is displayed.
- ◆ Press **Delete** to delete the character to the left of the cursor.
- ◆ Insert new character to the left of the cursor.
- ◆ When entering the time and date etc., edit the flashing character.

You will find explanations for the symbols and typographical conventions used in this user guide in the appendix, page 36.

Using the directory, direct dialling keys and lists

A directory, last number redial list, SMS list, calls list and answering machine list are available.

You can save up to 100 entries in the directory.

You can create a personalised directory for your own individual handset. However, you can send the list or individual entries to other handsets (page 18).

Directory



You can store numbers and the associated names in the **directory**. With the handset in idle status, open the directory by pressing the  key.

Length of an entry



Number: max. 22 digits

Name: max. 16 characters

Storing the first number in the directory

 → Dir empty New entry? → **OK**
 →  (Enter number) → **OK**
 →  (Enter name) → **OK**



Storing a number in the directory

 → **Menu** → New Entry → **OK**
 →  (Enter number) → **OK**
 →  (Enter name) → **OK**



Selecting a directory entry

 Open the directory.

You have the following options:

- ◆ Use  to scroll to the entry until the required name is selected.
- ◆ Enter the first character of the name, or scroll to the entry with .



Dialling with the directory

 →  (Select entry; page 17) → 

Managing directory entries

You have selected an entry (page 17).

Editing entries

Menu → Edit Entry → **OK**
 →  (Change number if required)
 → **OK**
 →  (Change name if required)
 → **OK**

Using other functions

The following functions can be selected with **Menu** → :

Use Number

Edit or add to a stored number. Then dial or use other functions with **Menu**.

Show Number

Show number.

Delete Entry

Delete selected entry.

Send Entry

Send a single entry to another handset (page 18).

Delete List

Delete **all** directory entries.



Send List

Send the complete list to another handset (page 18).

Sending the directory to another handset

Requirements:

- ◆ The sending and receiving handsets must both be registered on the same base station.
- ◆ The other handset and base station can send and receive directory entries.

 →  (Select entry; page 17)
→ **Menu** → Send Entry / Send List
→ **OK** →  (Enter the internal number of the receiving handset)
→ **OK**

A successful transfer is confirmed by a message and confirmation tone on the receiving handset.

Adding a displayed number to the directory

You can copy any numbers to the directory that appear in a list, for example the calls list or the last number redial list.

A number is displayed.

Menu → Copy to Directory → **OK**

- ▶ Complete the entry (page 17).

The message playback is interrupted during the number transfer from the answering machine list.

Direct dialling and SOS keys

You can store particularly important phone numbers, for example emergency numbers, under the 4 **direct dialling keys**. You can programme the direct dialling key I for SOS calls.

Dial the stored direct dialling number

- ◆ **on the base station** by pressing the corresponding direct dialling key,
- ◆ **on the handset** by pressing the corresponding direct dialling key and the talk key .

To initiate an SOS call, proceed as described in the Section "SOS procedure" (page 7).

Refer to the **font table** (page 40) for information on how to enter the text correctly.

The programmed assignment of the direct dialling keys and the SOS key applies both for the handsets and for the base station.

Please note:

The SOS key still works even if the keypad lock is switched on.

Storing/changing direct dialling/SOS keys

You can assign external phone numbers and the internal call function to the direct dialling keys. You should programme the direct dialling key I for SOS calls (page 19).

Menu → Settings → **OK** → Direct Diall.

Keys → **OK** → I: <no entry> → 

Select direct dialling key (I to IV)

Entering/changing an entry

You have selected a direct dialling key.

Menu → Edit Entry → **OK**



Enter or edit the number if required and press **OK**.



Enter or edit the name if required and press **OK**.

Using other functions

The following functions can be selected with **Menu** → :

Delete Entry

Delete selected entry.

Call. Home Internal

Pressing this key results in all registered handsets and the base station being called.

Use Number

Edit or add to a stored number. Then dial or use other functions with **Menu**.

Please note:

When a phone number is displayed on the screen, you can programme this number onto an unassigned direct dialling key by pressing and **holding** the relevant direct dialling key.

Programming SOS mode

Requirement: SOS mode is not activated.

Menu → Settings → **OK** → Direct Diall. Keys → **OK** → I: <no entry> (Direct dialling key I selected) → **Menu** → Emergency Call Mode → **OK**

If SOS mode has already been activated and is then reactivated, **Change no./ name?** appears in the display. Respond to the request

- ◆ with **Yes** to continue the procedure
- ◆ with **No** to continue with Label with Internal Call



Enter or edit the number if required and press **OK**.



Enter or edit the name if required and press **OK**.

Further number?

Confirm with **Yes** to enter additional SOS numbers. You can enter up to four SOS numbers.

Label with Internal Call

Confirm with **Yes** to initiate an internal call in addition to the stored numbers when the SOS key is pressed.

Record own name/addr.

Confirm with **Yes** to speak a message (e.g. name and address), which will be

announced automatically to the called user after pressing the SOS key. The announcement is played back for confirmation purposes and can be changed or deleted.

SOS mode is activated.

Please note:

After the SOS procedure is programmed, functionality should be tested.

Changing/deleting SOS numbers

Requirement: SOS mode is activated.

Menu → Settings → **OK** → Emergency Numbers → **Menu** → Edit Entry/Delete Entry → **OK**

Now change or delete the desired entries.

If your telephone is connected to a PABX, you may have to enter the access code (external line prefix) as the first digit of your entry (see the user guide for your PABX).

Please note:

The emergency call text that the recipient of your emergency call hears comprises two or three text parts. The callee first hears text part 1, then part 2 and finally part 3. If you have not added any personal emergency call text (text part 2), the emergency call only comprises text part 1 and text part 3.

- Text part 1 (predefined by default):
"This is an emergency call."
- Text part 2 (personal emergency call text):
You can speak this text yourself (see page 19). For example, you can state your name and address here. Example:
"This is John Smith, 8 Park Road, Suffolk IP25 9AL"
- Text part 3 (predefined by default):
"To accept this call, please press key 5."

Switching on/off SOS mode



Menu → Settings → **OK** → Emergency Call Mode → **OK** ( = on)

Having switched on SOS mode, proceed as described in the Section **Programming SOS mode** (page 19).

Last number redial list

The last number redial list contains the ten numbers last dialled with the handset (max. 22 digits). If one of the numbers is in the directory, then the corresponding name will be displayed.

Dialling from the last number redial list

- Redial** Press the display key.
-  Select an entry.
-  Press the talk key. The number is dialled.

Managing entries in the last number redial list

- Redial** Press the display key.
-  Select an entry.
- Menu** Press the display key.



The following functions can be selected with :

- Use Number (as in the directory, page 17)
- Copy to Directory (as in the directory, page 17)
- Delete Entry (as in the directory, page 17)
- Delete List (as in the directory, page 17)

Opening the message list with the display key

You can use the display key  to open the SMS list, the answering machine list, the network mailbox (if your network provider supports this function and the network mailbox is set up for speed dialling, page 30) and the calls list.

An advisory tone sounds as soon as a **new entry** appears in a list. A message appears in the display. If you press the display key , you will see all the lists that contain new messages. If only one list contains new messages, this list will be opened automatically. Press any key and the message advising of new messages is no longer shown on the display.

The display key  is faded out when the list is exited. Access to the the answering machine list can be initiated with key  on the handset (if the handset is set up for speed dialling) or the keys on the base station, while the SMS list and the calls list can be opened via the menu (see page 12). The display key  is available again after a new entry in one of the lists.

Please note:

If calls are stored in the network mailbox you will receive a message if the appropriate settings have been made (see the network mailbox instructions of your network provider).

Calls list

Requirement: CLIP (page 14)

The calls list contains

- ◆ missed calls

Depending on the list type selected, all numbers of the last 20 missed calls are stored.

The list is displayed as follows:

Calls List: 01+02

Number of new messages + number of old, read messages.

Selecting the list type for the calls list

Menu → **6msg** **8msg** **9msg** **1cd** **0+**

→ Enter digits: **1cd** = missed calls → **OK**

The entries in the calls list are preserved if you change the list type.

Opening the calls/answering machine list

Envelope icon → Calls List: / Voice Mail: 01+02
→ **OK**



Select entry.

The last call received is displayed as the first entry in the **calls list**.

The first new message received is displayed as the first entry in the **answering machine list**. The playback starts.

New messages are placed after old messages when they have been played back.

List entry

Example of a list entry:

New Call
1234567890
Back ◆ **Menu**

- ◆ Status of entry

In the calls list

New Call: new missed call.

Old Call: entry already read.

Only for list type "all calls":

Call Recv.: Call was answered.

Answer M.: The answering machine answered the call. A message was left.

In the answering machine list

New Msg.: New message on the answering machine.

Old Msg.: Previously heard message on the answering machine.

- ◆ Number or name of caller

You can add the number of the caller to the directory (page 18).

You can delete the current entry with

Menu → Delete Entry.

You can show the date and time of the call (if set, page 11) with **Menu** → Date and Time.

Dialling from the calls list

Open the calls list (see page 21).



Select an entry.



Press the talk key. The number is dialled.

Deleting the calls list

Caution! All **old and new** entries will be deleted.

Menu → Calls List: → **OK** → **Menu**
→ Delete List → **OK**



Press and **hold** (idle status).

Please note:

Deleting old messages from the answering machine list: page 28.

Automatic network provider code (preselection)

You can specify a call-by-call number (preselection number) which is **automatically** placed in front of certain numbers according to two lists when you dial them.

- ◆ The list "With Preselect" contains the "Rule": Prefix numbers or the first digits of prefix numbers, for which the preselection number is to be used.
- ◆ The list "Without Preselect" contains the "Exception to the rule".

Example:

You entered 08 for "With Preselect". Now all numbers that start with 08 will be dialled with preselection.

However, if you want, for example, that 081 is still dialled without preselection, enter 081 for "Without Preselect".

Storing preselection numbers

Menu → Settings → **OK** → Base → **OK**
→ Preselection → **OK** → Preselect
Number → **OK**

 Enter or edit preselection number (call-by-call number).

OK Press the display key. The entry is stored.

 Press and **hold** (idle status).

Saving or editing entries in the preselection lists

Each of the two lists can contain 11 entries with 4 digits.

- ▶ Numbers may be prefixed according to the country in the "With Preselect" list. This means, for example, that all national calls or calls to the mobile network are **automatically** linked to the preselection number you have stored previously.

Menu → Settings → **OK** → Base → **OK**
→ Preselection → **OK**
→ With Preselect / Without Preselect
→ **OK**

 Select entry and press **OK**.

 Enter or edit first digits of number.

OK Press the display key. The entry is stored.

 Press and **hold** (idle status).

Temporarily cancelling preselection

 (press and hold) → **Menu** → Preselect
off → **OK**

Permanently deactivating preselection

- ▶ Delete the preselection number with **Delete** and press **OK**.

SMS (text messages)

Your unit is supplied ready for you to send text messages immediately.

Requirements:

- ◆ Calling line identification presentation (CLIP, page 14) is enabled for your phone connection.
- ◆ Your network provider supports SMS in the fixed network (information on this can be obtained from your network provider).
- ◆ You are registered with your service provider to send and receive SMS.

Text messages are exchanged between SMS centres that are operated by service providers. You must enter the SMS centre through which you wish to send and receive in your unit. You can receive SMS from **every** SMS centre that is entered if you have registered with your service provider.

Your text message is sent through the SMS centre that is active (page 25). Only one SMS centre can be active at any one time.

If no SMS centre is entered, the SMS menu only consists of the entry Settings. Enter an SMS centre (page 24).

Please remember:

- ◆ If your phone is connected to a PABX, please read page 25.
- ◆ You must also have registered with your service provider for receiving SMS text messages.
- ◆ Each incoming SMS is signalled by a single ring (ringtone as for external calls). If you accept such a call, the SMS will be lost. To prevent this, suppress the first ringtone for all external calls (page 33).

Writing/sending an SMS

An SMS may contain up to 160 characters.

Writing/sending an SMS

Menu → **SMS** → **OK** → Write Message
→ **OK**



Write an SMS. For how to enter the text, see page 40.

Menu → Send Text

Select and press **OK**.



Enter the number with prefix (including your local area code) from the directory or key it in manually, and press **OK**.

For SMS to an SMS mailbox: put the mailbox ID at the **end** of the number.
The SMS is sent.

Please note:

If you are interrupted by an external call while writing an SMS, the text is automatically saved in the draft message list.

Draft message list

In the draft message list, you can save, edit later and send an SMS.

Saving an SMS in the draft message list

You are writing an SMS (page 23).

Menu → Save Text → **OK**

Opening the draft message list

Menu → **SMS** → **OK** → **Outgoing** → **OK**

The first entry in the list is displayed, e.g.:

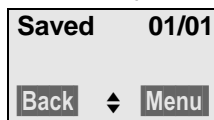

01/01: Current number/total number of SMS text messages

SMS (text messages)

Reading or deleting SMS messages

- ▶ Open the draft message list.



Select SMS.

Menu

Press the display key.

You have the following options:

Read SMS

Select and press **OK** to read the SMS message. Scroll in the SMS using

Delete Entry

Select and press **OK** to delete the SMS message.

Date/Time

Select and press **OK** to show when the SMS message was written.

Delete List

Select and press **OK** to delete all SMS messages in the draft message list.

Writing/editing an SMS

You are reading an SMS in the draft message list.

Menu

Press the display key.

You have the following options:

Write Message

Write and then send a new SMS (page 23) or save.

Use Text

Edit the text of the saved SMS and then send (page 23).

Receiving an SMS

All received text messages are saved in the incoming message list. Since an SMS remains in the list even after it has been read, you should **regularly delete SMS messages from the list**.

The display tells you if the SMS memory is full.

- ▶ Deleting text messages you no longer require (page 25).

Incoming list

The incoming message list contains:

- ◆ All received SMS messages, starting with the latest.
- ◆ SMS messages that could not be sent on account of an error.

New text messages are signalled on all Gigaset E36 handsets by a message in the display and an advisory tone.

Opening the incoming message list with the display key

Press

The incoming message list is displayed as follows (example):

SMS: 01+05

01+05: The number of new + the number of old, read messages

An entry in the list is displayed as follows for example:

New 01/02
1234567890
Back ⇅ Menu

01/02: Current Number of the SMS currently in the display / total number of new SMS messages

Opening the incoming message list via the SMS menu

Menu → SMS → **OK** → Incoming 01+05
→ **OK**

Reading or deleting SMS messages

- ▶ Open the incoming message list.



Select SMS.

Menu

Press the display key.

You have the following options:

Read SMS

Select and press **OK** to read the SMS message. Scroll through the SMS messages using . A new SMS message which you have read acquires the status Old.

Delete Entry

Select and press **OK** to delete the SMS message.

Copy to Directory

Select and press **OK** to copy the sender's number to the directory.

Date and Time

Select and press **OK** to show when the SMS message was received.

Delete List

Select and press **OK** to delete all SMS messages in the incoming message list.

Replying to or forwarding text messages

You are reading an SMS (page 25).

Menu

Press the display key.

You have the following options:

Reply

Write and send a reply SMS directly (page 23).

Use Text

Edit the text in the SMS and then send it (page 23).

Send Text

Forward the text of an SMS to another recipient (page 23).

Setting up the SMS centre

Entering/changing SMS centres

- ▶ Before changing or entering a new service number, make sure to find out about service offers and special features of your service provider.

Menu

→ SMS → **OK** → Settings → **OK**
→ Service Centres → **OK**



Select the SMS centre (e.g. Service Centre 1) and press **OK**.

You have the following options:

Activ. send Centre

If the SMS messages are to be sent through this SMS centre, press **OK** to activate the SMS centre (= on). If a different SMS centre was active previously, then this will be deactivated.

Centre No.

Enter the number of the SMS centre and press **OK**.

Sending an SMS through another SMS centre

- ▶ Activate the SMS centre (2 or 3) as the active send centre (page 25).
- ▶ Send the SMS.

SMS to a PABX

- ◆ You can only receive an SMS when **calling line identification presentation** (page 14) is forwarded to the extension of the **PABX (CLIP)**. The CLIP of the phone number for the SMS centre is evaluated in your **Gigaset**.
- ◆ Depending on your PABX, you may have to add the access code (external line prefix) before the number of the SMS centre.

If in doubt, test your PABX, for example by sending an SMS to your own phone number: once with the access code and once without.

SMS (text messages)

- ◆ When you send SMS messages, your sender number may be sent without your extension number. In this case the recipient cannot reply to you directly.

Sending and receiving SMS **on ISDN PABXs** is only possible via the MSN number assigned to your base station.

Activating/deactivating the SMS function

When you switch off you cannot send or receive any further SMS text messages with your phone.

Settings you have made for sending and receiving text messages (the numbers of SMS centres) and any entries in the incoming message and draft message lists will be retained even after the function is deactivated.

Menu → **6msg** **8txt** **9msg** **2abc** **6msg** → Enter digits: **0+** = Deactivate the SMS function; **1act** = Activate the SMS function (default status) → **OK**

SMS troubleshooting

Error codes when sending

If an SMS cannot be sent for a longer period of time, it is moved to the incoming message list and given the status Err. XX.

EO	Calling line identification permanently withheld (CLIR) or calling line identification presentation not activated.
FE	Error occurred during SMS transfer.
FD	Connection to SMS centre failed, see self-help.

Self-help with errors

The following table lists error situations and possible causes and provides notes on troubleshooting.

<p>You cannot send messages.</p> <ol style="list-style-type: none">1. You have not requested the CLIP service (calling line identification presentation, page 14).<ul style="list-style-type: none">▶ Ask your service provider to enable this service.2. Text message transmission has been interrupted (e.g. by a call).<ul style="list-style-type: none">▶ Re-send the text message.3. Network provider does not support this feature.4. No number or an invalid number is entered for the SMS centre activated as the send centre.<ul style="list-style-type: none">▶ Enter phone number (page 25).
<p>The SMS message is played back.</p> <ol style="list-style-type: none">1. The "display call number" service is not activated.<ul style="list-style-type: none">▶ Ask your service provider to enable this service (chargeable).2. Mobile phone/fixed network operator and network SMS service provider have not agreed on a cooperation.<ul style="list-style-type: none">▶ Obtain information from your network SMS service provider.3. You are not registered with your service provider to receive text messages. Please contact your service provider to sign up for this service.
<p>You cannot access the SMS functions on your handset.</p> <p>Another handset that is registered at the same base station is currently using the SMS functions.</p> <ul style="list-style-type: none">▶ Wait until there is no other handset using the SMS functions.

Operating the base station answering machine



You can operate the answering machine via the handset or using the keys on your base station (page 2).

Operation via the handset

The handset loudspeaker activates **automatically** if you receive an acoustic prompt or message while operating. You can switch it off with the handsfree key .

Switching answering machine on/off

Menu → Voice Mail → **OK** → Answer Machine → **OK** (M = on)

After switching on, the remaining memory time is announced. The  icon appears in the display. The  key lights up on the base station.

The telephone is supplied with a pre-recorded announcement. This pre-recorded announcement is used if no personal announcement is available.

If the memory is full the answering machine switches itself off automatically. It activates again automatically when you delete old messages.

Recording your own announcement

Menu → Voice Mail → **OK**
 → Announcements → **OK** → Record Announce. → **OK** → Start recording? → **OK**

You hear the ready tone (short tone).

- ▶ Now speak your announcement (at least 3 sec.).

Cancel recording with  or **Back**. Restart the recording with **OK**.

OK Press the display key to end the recording.

After recording, the announcement is played back for you to check.

Please remember:

- ◆ Recording ends automatically when the max. recording time of 170 seconds is reached or if there is a break in speaking of more than 2 seconds.
- ◆ If you cancel the recording, the pre-recorded announcement is then used.
- ◆ The recording is cancelled if the answering machine memory is full.
 - ▶ Delete old messages and repeat recording if required.

Playing back announcements

Menu → Voice Mail → **OK**
 → Announcements → **OK** → Play Announce. → **OK** →  press and **hold** (idle status)

You will hear the pre-recorded announcement if you have not recorded one of your own.

Deleting announcements

Menu → Voice Mail → **OK**
 → Announcements → **OK** → Delete Announce. → **OK**

The pre-recorded announcement is used again after a personal announcement is deleted.

Playing back messages

The date and time of each message is logged (provided this has been set, page 11). If calling line identification presentation is activated, the caller's number is displayed. If the caller's number is stored in the directory, the respective name is displayed.

Playing back new messages

New messages that have not yet been heard are indicated by a message on the display. The  key flashes on the base station.

Press the display key .

Voice Mail: 01+02

Select as required and press **OK**.



Playback begins with the first new message.

Playing back old messages

See answering machine list, page 21.

Stopping and controlling playback

During message playback:

 Pause playback. Press  again to resume.

 Go to the start of the current message.

2 x  To previous message.

 To next message.

2 x  To next-but-one message.

After an interruption of over one minute, the answering machine returns to idle status.

Marking a message as new

You can mark a message you have already heard as new again.

During message playback:

Menu → Mark as new → **OK**

Adding the telephone number of a message to the directory

See "Adding a displayed number to the directory", page 18.

Deleting messages

You can delete old messages either all together or individually.

Deleting all old messages

During playback or pause:

Menu → Delete all → **OK**



Deleting individual old messages

During playback:

Delete Press the display key.

Picking up a call from the answering machine

You can take a call while the answering machine is recording it.

 /  Press the talk or handsfree key.

Recording stops and you can speak to the caller.

If 3 seconds of the call have already been recorded when you pick it up, the call will be displayed as a new message.

You can answer the call even if it is not signalled on the handset.

Activating/deactivating call screening

While a message is recording, you can listen to it on the loudspeakers in the base and in the registered Gigaset E36 handsets.

Permanently activating/deactivating call screening

Menu → Voice Mail → **OK** → Call Screening
 → **OK** → Handset / Base → **OK**
 (☑ = on)

Call screening can be activated simultaneously on the Base and on the Handset.

Switching off call screening for the current recording



Press the end call key.

Setting up the answering machine

The answering machine has already been preset at the factory. Make individual settings using the handset.

Setting up call answering

You can define when you want the answering machine to answer a call.

Menu → Voice Mail → **OK** → Ring Delay
 → **OK**



Immediately / 10 sec / 20 sec / 30 sec / Auto . Select and press **OK**
 (☑ = on).

The following applies for call answering with Auto:

- ◆ If no new messages are present as yet, the answering machine answers a call after **20 seconds**.
- ◆ If new messages are present, the answering machine answers a call after just **10 seconds**.

Please remember:

You can set your telephone so that the **first** ringtone is **suppressed** for all calls (page 33). This means that the time selected for call answering predetermines how long the caller must wait before the answering machine answers the call.

Setting the recording time

You can set the maximum recording time of a message.

You can choose: 30 sec, 60 sec, 120 sec or Maximum.

Menu → Voice Mail → **OK** → Message Length → **OK**
 → Choose the recording time
 → **OK** (☑ = on)

Resetting speed dialling on the answering machine

The integrated answering machine is factory-set for speed dialling. However, if you have set the network mailbox for speed dialling (page 30), you can reset this setting.

Menu → Voice Mail → **OK** → Set Key 1
 → **OK** → Answer Machine → **OK**

When you have selected the answering machine, press and **hold** key 1. You will be connected directly.

The setting for speed dialling applies to all registered handsets.

Using the network mailbox

The network mailbox is your network provider's answering machine. You cannot use the network mailbox unless you have **applied** to your network provider.

Using the network mailbox for setting speed dialling

With speed dialling, you can direct dial either the network mailbox or the integrated answering machine directly.

The integrated answering machine is pre-configured for speed dialling. You can configure the network mailbox instead. Obtain information from your network provider.

Configuring the network mailbox for speed dialling and entering the network mailbox number

Menu → **Voice Mail** → **OK** → **Set Key 1**
→ **OK** → **Network Mailbox** → **OK**
(**1** = on) → Enter the number of the network mailbox → **OK**

This setting is now valid for all registered handsets.

Calling the network mailbox

1so Press and **hold**. This connects you directly to the network mailbox.

Using several handsets

Registering handsets

You can register up to four handsets on your base station.

Automatic registration Gigaset E36 on Gigaset E365, see page 10.

Manual registration Gigaset E36 on Gigaset E365

You must activate manual registration of the handset on both the handset and the base station.

After it has registered, the handset returns to idle status. If several handsets are registered on the base, the internal number is shown in the display after registration, e.g. 2.

The registration process is cancelled after 60 seconds. If the handset has not registered within this time, repeat the process.

On the handset

Menu → **Settings** → **OK** → **Handset** → **OK**
→ **Register Handset** → **OK** →
Enter system PIN of base station
(default status: 0000) → **OK**

On the base station

☎ Press and hold the registration/paging key on the base station (page 2) (min. 1 sec.).

Registering other handsets

You can register other Gigaset handsets and handsets for other devices with GAP functionality as follows.

On the handset: Start to register the handset as described in its user guide.



On the base station: Press and hold the registration/paging key **☎** on the base station (page 2) (min. 1 sec.).

Locating a handset ("Paging")

You can locate your handset using the base station.

- ▶ Press the registration/paging key  on the base station (page 2) **briefly**.
- ▶ All handsets will ring at the same time ("paging"), even if the ring tones are switched off.



Ending paging

Briefly press the registration/paging key  on the base station (page 2) or press the talk key  on the handset.

Making internal calls

Internal calls are free calls between handsets that you have registered on the same base station or calls between a handset and the base station. In order to be able to initiate an internal call, one of the speed dialling keys must be programmed for internal calls (see page 18).

Calling other handsets



Press the relevant speed dialling key ( ... ) which is programmed for internal calls when the handset or base station is in idle mode. If the internal call is initiated on the base station, all handsets are called immediately. If the internal call is initiated on the handset, the query Call home internal? must be acknowledged with **Yes**. You will see the message Calling all handsets on the display.

Please note:



If no user connects, the handset or the base station switches to idle mode after 3 minutes.

Answering an internal call

Your phone rings and the internal number of the caller is displayed on the screen, for example 2. If the call is coming from the base station, 0 is displayed.

Press the talk or handsfree key  /  on the handset **or** the handsfree key  on the base station to answer the call.

Ending a call



Press the end call key  on the handset **or**  the handsfree key on the base station.

Transferring a call to another handset/ internal consultation

You are calling an **external** number.

- ▶ Initiate an internal call, see "Calling other handsets" auf Seite 31. (You can press the display key **Back** during the internal call and are connected again to the external caller.)

When an internal call gets answered:





- ◆ **To transfer** to the internal number, press the end call key  on the handset **or** the handsfree key  on the base station.
- ◆ The internal caller must end the call **to terminate the consultation**. You are reconnected with the external caller.

Please note:

You can also press the end call key  **before** connecting the internal caller. If the internal party does not answer, or their phone is in use, the call will automatically return to you.

Accepting a waiting call

If you get an **external** call while conducting an **internal** call, you will hear the call waiting tone (short tone). The caller's number will appear in the display if calling line identification is enabled.

- ▶ Press the end call key  on the handset **or** the handsfree key  on the base station to end the internal call.
- ▶ Press the talk key  on the handset **or** the handsfree key  on the base station to answer the external call.

Listening in to an external call



You want to listen in to an existing external call.

Requirement: The Listening in function must be activated.



Activating/deactivating the function:

Menu → Settings → **OK** → Base → **OK**
→ Listening in → **OK** (✓ = on)

Listen in to call:

Press the talk key  on the handset **or** the handsfree key  on the base station. All participants hear a signal tone. Conf. Call is shown on the handset display.

Ending listening in:

Press the end call key  on the handset **or** the handsfree key  on the base station so that all participants hear a signal tone.

If the **first** internal participant presses the end call key , the handset that has 'listened in' remains connected to the external caller.

Handset settings

Your handset comes with default settings. You can change the individual settings.



Changing the display language

You can view the display texts in different languages.

Menu → Settings → **OK** → Language
→ **OK** →  (Choose language)
→ **OK**

The current language is indicated by ✓.

If you accidentally choose a language you do not understand:

Menu →   → 
(Choose language) → **OK**

Screensaver

When this function is activated, the time is shown in digital in idle mode, filling the entire display.

Menu → Settings → **OK** → Handset → **OK**
→ Screen Saver → **OK** (✓ = on)

Auto answer

When this function is activated, when a call arrives you can simply lift the handset out of the base without having to press the talk key .

Menu → Settings → **OK** → Handset → **OK**
→ Auto Answer → **OK** (✓ = on)

Adjusting the loudspeaker volume

You can set the loudspeaker volume for handsfree talking and the earpiece volume to five different levels (1–5; e.g. volume 2 = ) .

Menu → Audio Settings → **OK** → Handset Volume / Handsfree Volume → **OK**



Adjust the volume and press **OK**.

Adjust the volume during a call:





Press the control key.



Adjust the volume and press **OK**.

Changing ringtones

◆ Volume:

Five volume levels (1-5; e.g. volume 2 = ) and "off" (volume 0 = ) .

◆ Melody:

List of pre-loaded ringer melodies. The first three melodies are the "classical" ring tones.

You can also set different melodies for the following functions:

- ◆ External Calls: For external calls
- ◆ Internal Calls: For internal calls
- ◆ Alarm Clock: For the alarm clock

For how to set the ringtones for the base station, see page 35.

Setting ringer volume

The ringer volume is the same for all types of signalling.



Menu → Audio Settings → **OK** → Ringer Volume → **OK** →  (Adjust volume) → **OK**

Or in idle status:

 Press briefly →  (Adjust volume) → **OK**





Setting ringer melody

Set different ringer melodies for external calls, internal calls and the alarm clock.

Menu → Audio Settings → **OK** → Ringer Melody → **OK** → External Calls / Internal Calls / Alarm Clock → **OK**
→  (Select melody)
→ **OK** ( = on)

Activating/deactivation suppression of the first ringtone

The phone identifies an incoming SMS from the first network signal.

Menu → **6**  **8**  **9**  **2**  **5** 
→ Enter digits: **0+** = make first ringtone audible; **1su** = suppress first ringtone → **OK**

Please remember:

If first ringtone muting is deactivated, then every incoming SMS will be signalled by a ringtone. If you take this type of "call" at the first ringtone, you will lose the SMS.

Advisory tones

Your handset uses 'advisory tones' to tell you about different activities and statuses. The following tones can be activated and deactivated independently of each other:

◆ Advisory tones:

- **Key click:** Each key press is acknowledged.
- **Confirmation tone** (rising tone sequence): at the end of an entry/setting, when the handset is placed in the base station and on arrival of an SMS or a new entry in the answering machine list or the calls list.
- **Error tone** (descending tone sequence): when you make an incorrect entry.

Base station settings

- **Menu end tone:** when scrolling at the end of a menu.

- ◆ **Battery warning tone:** The battery requires charging.

You cannot deactivate the confirmation tone for placing the handset in the base station.

Activating/deactivating advisory tones

Menu → Audio Settings → **OK** → Advisory Tones → **OK** (🔔 = on)

Setting the battery warning tone

Menu → Audio Settings → **OK** → Battery Low → **OK** → On / Off / During Call → **OK** (🔔 = on)

The battery warning tone is activated or deactivated or sounds during a call.

Using the handset as an alarm clock

Activating/deactivating the alarm clock

Requirement:

The time is set (see page 11).

Menu → Alarm Clock → **OK** → Activation → **OK** (🔔 = on)

After you activate the alarm clock, the menu for setting the wake up time opens automatically.

If the alarm clock is set, the wake up time appears with the 🕒 icon in the display.

Setting the wake up time

Menu → Alarm Clock → **OK** → Wakeup time → **OK** → Enter wake up timen → **OK**

When the alarm clock rings...

Press the display key **Off** or any key to deactivate the alarm clock for 24 hours.

If you do not press any key, the alarm clock switches off after one minute.

Restoring the handset default settings

You can reset any individual settings and changes that you have made. This will not affect entries in the directory, calls list, or SMS lists or the handset's registration on the base station.

Menu → Settings → **OK** → Handset → **OK** → Reset Handset → **OK**

Cancel the reset with 🔄.

Base station settings

The base station settings are carried out using a registered Gigaset E36 handset.

Changing the system PIN

You have to enter the system PIN when registering a handset on the base station.

You can change the base's 4-digit default system PIN ("0000") to a 4-digit PIN known only to yourself.

Menu → Settings → **OK** → Base → **OK** → System PIN → **OK** → PIN: → **OK** → New PIN: → **OK**

Should you forget the system PIN, you can reset the base station to the original code 0000:

Remove the mains cable from the base station. Press and hold down the registration/paging key 📞 on the base station while you reconnect the mains cable to the base station. Only release the key when you hear a signal tone.

The base station is now reset and the system PIN is set to 0000.

Changing ringtones

◆ Volume:

You can choose between five volumes, see page 33. Select "0" to deactivate the ringtone on the base station.

◆ Melody:

You can set a ringtone melody for external calls, see page 33.

Menu → Settings → **OK** → Base → **OK**
→ Audio Settings → **OK** → Ringer Volume /
Ringer Melody → **OK**

For how to adjust the settings, see page 33.

Restoring the base station to factory settings

When the settings are restored all handsets are de-registered. Each individual setting is restored. Only the date and time are retained.

Menu → Settings → **OK** → Base → **OK**
→ Base Reset → **OK**

Operating the base station on the PABX

The following settings are only needed when your PABX requires them. Please refer to the user guide for your PABX.

You cannot send or receive SMS messages on PABXs that do not support Calling Line Identification.

Changing the dialling mode

Menu → **6** **mn** **8** **tnv** **9** **myd** **1** **cd** **1** **cd** → Enter digits for dialling mode: **0** **+** = Dual-tone multifrequency dialling (DTMF); **1** **cd** = Pulse dialling (PD) → **OK**

Switching temporarily to dual-tone multifrequency dialling (DTMF)

If your PABX is still using pulse dialling (PD) but tone dialling is required for a con-

nection (e.g. to play back the network mailbox), you have to switch temporarily to tone dialling.

Requirement: You are currently conducting a call or have already dialled an external number.

Press the asterisk key ***R**. Tone dialling is activated **for this connection only**.

Setting the flash time

Menu → **6** **mn** **8** **tnv** **9** **myd** **1** **cd** **2** **abc** → Enter digits for flash time: **0** **+** = 80 ms;
1 **cd** = 100 ms; **2** **abc** = 120 ms;
3 **def** = 180 ms; **4** **ghi** = 250 ms;
5 **jkl** = 300 ms; **6** **mno** = 600 ms;
7 **pqr** = 800 ms → **OK**

Changing pause after line seizure

You can set the length of the pause inserted between pressing the talk key **r** and sending the phone number.

Menu → **6** **mn** **8** **tnv** **9** **myd** **1** **cd** **9** **myd** → Enter digits for the current pause length: **1** **cd** = 1 sec.;
2 **abc** = 3 sec.; **3** **def** = 7 sec. → **OK**.

Changing the pause after the recall key

Menu → **6** **mn** **8** **tnv** **9** **myd** **1** **cd** **4** **ghi** → Enter the digits for the current pause length:
1 **cd** = 800 ms; **2** **abc** = 1600 ms;
3 **def** = 3200 ms → **OK**

Appendix

Symbols and typographical conventions used

This section explains the meaning of certain symbols and typographical conventions that are used in this user guide.



Enter digits or letters.



The display functions currently in the bottom display line are shown in reverse video. Press the relevant display key to launch the function.



Press the top or bottom of the control key, e.g. when scrolling.

/ / etc.

Press the illustrated key on the handset.

External Calls / Internal Calls (example)

Select one of the menu functions (External Calls or Internal Calls) from the list and press **OK**.

Menu → Audio Settings → **OK** → Ringer Melody (example) → **OK**

Press **Menu**. Select Audio Settings using and press **OK**. Select Ringer Melody using and press **OK**.

Care

Wipe the base station, charging cradle and handset with a **damp** cloth (do not use solvent) or an antistatic cloth.

Never use a dry cloth. This can cause static.

Contact with liquid

If the handset has come into contact with liquid:

1. **Switch off the handset and remove the battery pack immediately.**
2. Allow the liquid to drain from the handset.
3. Pat all parts dry, then place the handset with the battery compartment open and the keypad facing down in a dry, warm place **for at least 72 hours** (not in a microwave, oven etc.).
4. **Do not switch on the handset again until it is completely dry.**

When it has fully dried out, you will normally be able to use it again.

Questions and answers

If you have any questions about using your phone, visit us anytime at www.gigaset.com/customer-care. The table below contains a list of common problems and possible solutions.

The display is blank.

1. The handset is not switched on.
 - ▶ Press and **hold** the end call key .
2. The battery is flat.
 - ▶ Charge the battery or replace it (page 9).

The handset does not respond to a key press.

- The keypad lock is activated.
- ▶ Press and **hold** the hash key (page 15).

<p>Base is flashing in the display.</p> <ol style="list-style-type: none"> The handset is outside the range of the base station. <ul style="list-style-type: none"> ▶ Move the handset closer to the base. The base station is not switched on. <ul style="list-style-type: none"> ▶ Check the base station mains adapter (page 8).
<p>Handset does not ring.</p> <p>The ringtone is switched off.</p> <ul style="list-style-type: none"> ▶ Activate the ringtone (page 33).
<p>You cannot hear a ringtone/dialling tone.</p> <p>Base station's phone cord has been replaced.</p> <ul style="list-style-type: none"> ▶ When purchasing a new cord, ensure that it has the correct pin connections (page 9).
<p>The incoming call number is not displayed although CLIP (page 14) is set.</p> <p>Phone number identification is not enabled.</p> <ul style="list-style-type: none"> ▶ The caller should ask his/her network provider to enable calling line identification (CLI).
<p>You hear an error tone when keying an input (a descending sequence of tones).</p> <p>Action has failed/invalid input.</p> <ul style="list-style-type: none"> ▶ Repeat the operation. Watch the display and refer to the operating instructions if necessary.
<p>The calls list does not indicate a time for a message.</p> <p>Date/time are not set.</p> <ul style="list-style-type: none"> ▶ Set the date/time (page 11).
<p>The answering machine will not record any messages.</p> <p>Its memory is full.</p> <ul style="list-style-type: none"> ▶ Delete old messages. ▶ Play back new messages and delete.
<p>Programming of SOS mode did not work.</p> <p>The feature is only available behind extension systems that do not require an "R" or a "P" for obtaining an outside line.</p>

Service (Customer Care)

We offer you support that is fast and tailored to your specific needs!

Our Online Support on the Internet can be reached any time from anywhere.

www.gigaset.com/customercare

It provides you with 24/7 support for all our products. It also provides a list of FAQs and answers plus user guides and current software updates (if available for the product) for you to download.

You will also find frequently asked questions and answers in the appendix of this user guide.

For personal advice on our range of products and assistance with repairs or guarantee/warranty claims you can contact us on:

UK helpdesk: 0 84 53 67 08 12.

Please have your proof of purchase ready when calling with regard to guarantee/warranty claims.

Replacement or repair services are not offered in countries where our product is not sold by authorised dealers.

Authorisation

This device is intended for analogue phone lines in the UK.

Country-specific requirements have been taken into consideration.

We, Gigaset Communications GmbH, declare that this device meets the essential requirements and other relevant regulations laid down in Directive 1999/5/EC.

A copy of the 1999/5/EC Declaration of Conformity is available at this Internet address:

www.gigaset.com/docs.



Technical data

Recommended batteries

(Valid at the time of going to press)

Nickel-metal-hydride (NiMH):

- ◆ Sanyo Twicell 650
- ◆ Sanyo Twicell 700
- ◆ Sanyo NiMH 800
- ◆ Panasonic 700 mAh "for DECT"
- ◆ GP 700mAh
- ◆ GP 850mAh
- ◆ Yuasa Technology AAA Phone 700
- ◆ Yuasa Technology AAA 800
- ◆ VARTA Phone Power AAA 700mAh

The handset is supplied with two recommended batteries.

Handset operating times/charging times

The following information relates to batteries with a capacity of 650mAh.

Standby time	approx 165 hours (7 days)
Calling time	approx. 18 hours
Charging time	approx. 6 hours

The operating and charging times apply only when using the recommended batteries.

Base station power consumption

In standby mode: approx. 2W

During a call: approx. 3W

General specifications

DECT standard	is supported
GAP standard	is supported
Range	up to 300 m outdoors, up to 50 m indoors
Base station power supply	230 V ~/50 Hz
Environmental conditions for operation	+5 °C to +45 °C; 20 % to 75 % relative humidity

Guarantee Certificate

United Kingdom

Without prejudice to any claim the user (customer) may have in relation to the dealer or retailer, the customer shall be granted a manufacturer's Guarantee under the conditions set out below:

- ◆ In the case of new devices and their components exhibiting defects resulting from manufacturing and/or material faults within 24 months of purchase, Gigaset Communications shall, at its own option and free of charge, either replace the device with another device reflecting the current state of the art, or repair the said device. In respect of parts subject to wear and tear (including but not limited to, batteries, keypads, casing), this warranty shall be valid for six months from the date of purchase.
- ◆ This Guarantee shall be invalid if the device defect is attributable to improper treatment and/or failure to comply with information contained in the user guides.
- ◆ This Guarantee shall not apply to or extend to services performed by the authorised dealer or the customer themselves (e. g. installation, configuration, software downloads). User guides and any software supplied on a separate data medium shall be excluded from the Guarantee.
- ◆ The purchase receipt, together with the date of purchase, shall be required as evidence for invoking the Guarantee. Claims under the Guarantee must be submitted within two months of the Guarantee default becoming evident.
- ◆ Ownership of devices or components replaced by and returned to Gigaset Communications shall vest in Gigaset Communications.
- ◆ This Guarantee shall apply to new devices purchased in the European Union. For Products sold in the United





Kingdom the Guarantee is issued by: Gigaset Communications GmbH, Schlavenhorst 66, D-46395 Bocholt, Germany.

- ◆ Any other claims resulting out of or in connection with the device shall be excluded from this Guarantee. Nothing in this Guarantee shall attempt to limit or exclude a Customers Statutory Rights, nor the manufacturer's liability for death or personal injury resulting from its negligence.
- ◆ The duration of the Guarantee shall not be extended by services rendered under the terms of the Guarantee.
- ◆ Insofar as no Guarantee default exists, Gigaset Communications reserves the right to charge the customer for replacement or repair.
- ◆ The above provisions does not imply a change in the burden of proof to the detriment of the customer.

To invoke this Guarantee, please contact the Gigaset Communications telephone service. The relevant number is to be found in the accompanying user guide.

Writing and editing a text message

The following rules apply when writing a text message:

- ◆ The cursor is controlled with  .
- ◆ Characters are added to the left of the cursor.
- ◆ Press the hash key  **briefly** to switch from "Abc" mode to "123", from "123" to "abc" and from "abc" to "Abc" (uppercase: 1.st letter uppercase, all others lowercase). Press the hash key  **before** entering the letter.
- ◆ Press the hash key  **three times**: Shows the selection line of the characters assigned to the hash key.
- ◆ The first letter of the name of directory entries is automatically capitalised, followed by lowercase letters.

Editing text

When you press a key and **hold** it, the characters of that key appear in the bottom display line and are highlighted one after the other. When you release the key, the highlighted character is inserted into the input field. For how to enter special characters, see page 40.

The display briefly shows whether uppercase or lowercase letters or digits are selected when you switch from one mode to the next: The bottom text line displays "abc -> Abc", "Abc -> 123" or "123 -> abc".

Order of directory entries





The directory entries are usually sorted in alphabetical order. Spaces and digits take first priority. The sort order is as follows:

1. Space (shown here as )
2. Digits (0–9)
3. Letters (alphabetical)
4. Other characters

To get round the alphabetical order of the entries, insert a space or a digit in front of the name. These entries will then move to the beginning of the directory. Names that you have preceded with an asterisk will move to the end of the directory.

Entering special characters

Standard characters

				
	*)	**)	.	*
1x	Space	Space	.	Abc-> 123
2x	1	↵	,	/
				123 -> abc
3x	£	1	?	(
4x	\$	€	!)
				@
5x	¥	£	0	<
				\
6x	□	\$	+	=
				&
7x		¥	-	>
				§
8x		□	:	%
9x			¿	
10x			i	
11x			"	
12x			'	
13x			;	
14x			_	

*) Directory and other lists

***) When writing an SMS

Accessories

Gigaset E36 handset

Upgrade your Gigaset to a cordless telephone system.

Gigaset E36 handset

- ◆ Large keys, illuminated keypad
- ◆ Text and symbols are shown clearly in large type on the display
- ◆ Jumbo digits (uppercase)
- ◆ Direct dialling keys
- ◆ Compatibility with hearing aids (HAC)
- ◆ Handsfree operation
- ◆ Phonebook for around 100 entries
- ◆ SMS (prerequisite: CLIP available)
- ◆ Headset connection

www.gigaset.com/gigasete36



Connection socket for headset

You will find suitable headsets on the Internet at www.plantronics.com.

Wall mounting for base station

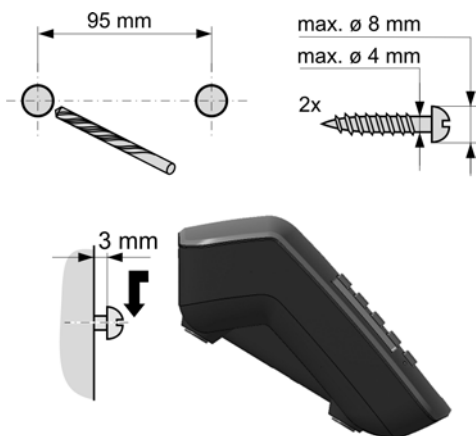

Index

A

- Accessories 41
- Activating
 - advisory tones 33
 - answering machine 27
 - auto answer 32
 - keypad lock 15
 - SMS function 26
 - suppressing ringtone 33
- Activating/deactivating SMS function . 26
- Advisory tones 33
- Alarm clock 34
- Answering machine 27
- Answering machine, see also Network mailbox
- Authorisation 38
- Auto answer 14, 29, 32
- Automatic network provider code . . . 22

B

- Base station
 - changing system PIN. 34
 - installing and connecting 8
 - operating on PABX 35
 - power consumption 38
 - restoring default settings 35
 - setting 34
 - wall mounting 41
- Battery
 - charging. 11
 - display 1, 11
 - fitting. 9
 - icon 11
 - recommended batteries 38
 - warning tone 34

C

- Call
 - answering 14
 - caller listening in 32
 - internal 31
 - picking up from answering
 - machine 28
 - transferring (connecting) 31
- Call screening during recording 29
- Call waiting, internal call 31

- Calling back caller 21
- Calling back from calls list 21
- Calling line identification. 14
- Calls list 20, 21
- Cancelling (operation). 16
- Care of the telephone 36
- Changing PIN 34
- Changing system PIN. 34
- Characters
 - deleting. 16
- Charge status (battery) 1, 11
- Charge status display 11
- CLI 14
- CLI, CLIP 14
- CLIP 14
- Confirmation tone. 33
- Connection socket for headset. . . . 1, 41
- Control key 1, 15
- Correcting incorrect input 16
- Customer Care 37

D

- Deactivating
 - advisory tones 33
 - answering machine 27
 - auto answer 32
 - keypad lock 15
 - SMS function. 26
 - suppressing ringtone 33
- Dialling
 - directory 17
- Dialling mode 35
- Direct dialling keys 6
- Directory 17
 - opening 15
 - order of entries 40
 - selecting entry. 17
 - sending entry/list to handset 18
 - storing entry 17
 - storing the first number 17
- Display
 - changing display language. 32
 - in idle status 1
 - number (CLI/CLIP) 14
 - setting 32
- Display keys 1, 16
- Displaying
 - phone number (CLIP). 14

- E**
- Earpiece volume 33
 - Electricity consumption, see
Power consumption
 - Emergency call 6
 - End call key 1, 14
 - Entering flash 1
 - Error tone 33
- G**
- Guarantee Certificate 39
- H**
- Handset
- activating/deactivating 15
 - advisory tones 33
 - contact with liquid 36
 - display language 32
 - idle status 16
 - loudspeaker volume 33
 - operating and charging times 38
 - registering 30
 - restoring default settings 34
 - searching for 31
 - setting (individual) 32
 - setting up for use 9
 - transferring a call 31
- Handsfree operation 15
- key 1
- Hash key 1, 15
- Headset 1, 41
- Hearing aids 5
- I**
- Idle status (display) 1, 16
 - Incorrect input (correction). 16
 - Installing, base station 8
- Internal
- listening in 32
 - making calls 31
- Internal call 31
- call waiting 31
- K**
- Key click 33
 - Keypad lock 15
- Keys
- control key 1, 15
 - direct dialling keys 6
 - display keys 1, 16
 - end call key 1, 16
 - handsfree key 1
 - hash key 1, 15
 - key 1 (speed dialling) 29
 - keypad lock 15
 - message key 20
 - on/off key 1
 - paging key 2
 - recall key 1
 - SOS key 6
 - speed dialling 29
 - talk key 1
- L**
- Last number redial 20
 - Liquid 36
- List
- calls list 20, 21
 - draft message list (SMS) 23
 - entry 21
 - incoming message list (SMS) 24
 - last number redial list 20
 - missed calls 21
- Listening in to call 32
- Lock (keypad) 15
- Loudspeaker volume 33
- M**
- Mains adapter 5
- Making calls
- answering a call 14, 15
 - external 14
 - internal 31
- Making cost-effective calls 21
- Medical appliances 5
- Menu
- back one menu level 16
 - end tone 34
 - menu guidance 16
 - overview 12
- Message
- copying number to the directory 28
 - deleting 28
 - marking as new 28
 - playing back 28
- Message key
- opening list 24
 - opening lists 20
- Missed call 21

N

- Network mailbox 30
- Network provider code, automatic . . . 22
- Number
 - displaying caller's number (CLIP) . . . 14
 - setting for SMS centre 25
 - storing in directory 17, 18

O

- On/off key 1
- Operation (preparing to use
 - the phone) 8
- Order of entries in directory 40

P

- PABX
 - operating base station on PABX 35
 - setting dialling mode 35
 - setting flash time 35
 - SMS 25
 - switching to tone dialling 35
- Pack contents 8
- Paging 2, 31
- Phone jack assignment 9
- Phone number
 - displaying caller's number (CLIP) . . . 14
- Playing back
 - announcement (answering
 - machine) 27
 - message (answering machine) 28
- Playing back/deleting announcements
 - (answering machine) 27
- Power consumption (base station) . . . 38
- Preselection 22
 - saving, changing entry 22

Q

- Questions and answers 36

R

- Recall key 1
- Recording time (answering machine) . . 29
- Registering (handset) 10, 30
- Restoring default settings
 - base station 35
 - handset 34
- Ringtone
 - changing 33, 35
 - setting melody 33

- setting volume 15, 33
- suppressing 33

S

- Safety precautions 5
- Searching
 - handset 31
 - in directory 17
- Sending
 - directory entry to handset 18
 - SMS 23
- Service 37
- Setting date 11
- Setting flash time (PABX) 35
- Setting melody (ringtone) 33
- Setting time 11
- Setting volume
 - earpiece 33
 - handset loudspeaker 33
 - loudspeaker 33
 - ringtone 33
- Setting wake up time 34
- Shortcut (digit combination) 12
- SMS 23
 - deleting 24
 - draft message list 23
 - forwarding 25
 - incoming message list 24
 - reading 24
 - replying to and forwarding 24
 - self help with error messages 26
 - send centre 23
 - sending 23
 - to PABX 25
 - troubleshooting 26
 - writing 23
 - writing text 40
- SMS centre
 - changing number 25
 - setting 25
- SOS mode 6
- Special characters 40
- Speed dialling
 - answering machine 29
 - network mailbox 30
- Speed dialling list 18
- Suppressing
 - first ring 33
 - preselection 22

T

Talk key	1
Technical data	38
Text message, see SMS	
Tone dialling	35
Troubleshooting	36
SMS	26

V

Volume	
ringtone	33

W

Wall mounting for base station	41
Warning tone (battery)	34
Writing, editing text	40