

## Handset at a glance

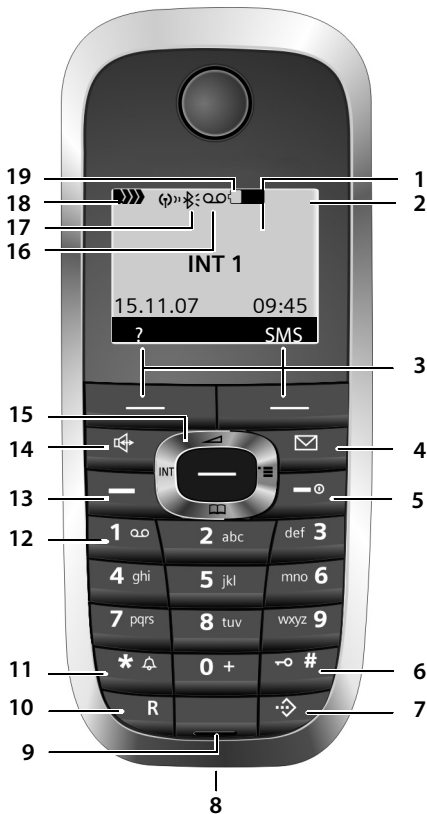

- 1 **Display** (screen) in idle status
- 2 **Charge status of the battery pack**  
  
 ◻ flashes: battery pack almost flat  
  
 ◻ flashes: battery pack charging
- 3 **Display keys** (→ page 10)
- 4 **Message key**  
 Access to calls and message lists;  
 Flashes: new message or new call
- 5 **End call key, On/Off key**  
 End call, cancel function, go back one menu level (press briefly), back to idle status (press and hold), activate/deactivate handset (press and hold in idle status)
- 6 **Hash key**  
 Keypad lock on/off (press and hold in idle status),  
 Toggle between upper/lower case and digits (press and hold)
- 7 **Call-by-call list key**  
 Open call-by-call list
- 8 **Connection socket** for PC interface
- 9 **Microphone**
- 10 **Recall key**  
 - Confer (flash)  
 - Insert a dialling pause (press and hold)
- 11 **Star key**  
 Ringer tones on/off (press and hold),  
 With an open connection: switch between dial pulsing/touch tone dialling (press briefly),  
 Open special characters table
- 12 **Key 1**  
 Select answer machine (Gigaset SL375 only)/  
 network mailbox (press and hold)
- 13 **Talk key**  
 Answer a call, open last number redial list (press briefly), start dialling (press and hold)  
 When writing a SMS: send SMS
- 14 **Handsfree key**  
 Switch between earpiece and handsfree mode;  
 Lights up: handsfree activated;  
 Flashes: incoming call
- 15 **Control key** (→ page 10)
- 16 **Bluetooth activated** (→ page 54)
- 17 **Eco mode activated** (→ page 12)
- 18 **Signal strength**  
  
 ◻ flashes: no reception
- 19 **Answer machine icon** (Gigaset SL375 only):  
 answer machine switched on;  
 Flashes: answer machine is recording a message or is being operated by another internal party

## Base station at a glance

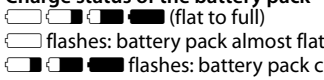
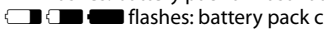
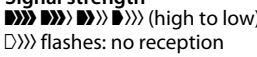

Registration/paging key (page 4).

# Contents

---

<b>Handset at a glance</b> .....	<b>1</b>
<b>Base station at a glance</b> .....	<b>1</b>
<b>Safety precautions</b> .....	<b>4</b>
<b>Gigaset SL370/SL375 – More than just a telephone</b> .....	<b>6</b>
<b>First steps</b> .....	<b>6</b>
Pack contents .....	6
Installing the base station and charging cradle .....	6
Setting up the handset for use .....	7
<b>Operating the handset</b> .....	<b>10</b>
Control key .....	10
Display keys .....	10
Reverting to idle status .....	11
Menu guidance .....	11
Correcting incorrect entries .....	12
<b>ECO DECT</b> .....	<b>12</b>
<b>Menu tree</b> .....	<b>13</b>
<b>Making calls</b> .....	<b>16</b>
Making an external call .....	16
Ending a call .....	16
Accepting a call .....	16
Calling Line Identification .....	16
Handsfree talking .....	17
Muting .....	17
<b>Making calls using network services</b> .....	<b>18</b>
<b>Using the directory and lists</b> .....	<b>19</b>
Directory/call-by-call list .....	19
Last number redial list .....	22
Opening lists with the message key .....	23
<b>Making cost-effective calls</b> .....	<b>25</b>
Linking call-by-call numbers with one number .....	25
Automatic network provider preselection (Preselection) .....	25
<b>SMS (text messages)</b> .....	<b>27</b>
Writing/sending a SMS .....	27
Receiving a SMS .....	29
Notification by SMS .....	30
SMS mailboxes .....	31
Setting SMS centres .....	32
SMS info services .....	32
SMS on a PABX .....	33
Activating/deactivating the SMS function .....	33
SMS troubleshooting .....	34
<b>Answer machine operation (Gigaset SL375 only)</b> .....	<b>35</b>
Operation via the handset .....	35
Activating/deactivating call screening .....	38
Setting up the answer machine .....	39
Resetting fast access for the answer machine using key 1 .....	39
Operating when on the move (remote control) .....	39
<b>Using the network mailbox</b> .....	<b>41</b>
Configuring fast access for the network mailbox .....	41
Viewing the network mailbox report .....	41
<b>Using several handsets</b> .....	<b>42</b>
Registering handsets .....	42
De-registering handsets .....	42
Locating a handset ("paging") .....	42
Changing the base station .....	42
Making internal calls .....	43
Listening in to an external call .....	44
Changing the name of a handset .....	44
Changing a handset's internal number ..	44
Using a handset as a room monitor .....	45
Walky-talky mode .....	46
<b>Handset settings</b> .....	<b>47</b>
Shortcuts for functions and numbers .....	47
Changing the display language .....	48
Setting the display .....	48
Setting the screensaver .....	48

Setting the display backlight ..... 49

Activating/deactivating  
auto answer ..... 49

Changing the handsfree/  
earpiece volume ..... 49

Changing ringer tones ..... 49

My stuff ..... 51

Activating/deactivating  
advisory tones ..... 52

Setting the alarm clock ..... 52

Setting an appointment (calendar) ..... 53

Displaying missed appointments  
and anniversaries ..... 54

Using Bluetooth devices ..... 54

Setting your own area code ..... 56

Restoring the handset to  
factory settings ..... 56

**Base station settings ..... 57**

Protecting against unauthorised access . 57

Activating/deactivating  
music on hold ..... 57

Repeater support ..... 57

Restoring the base station to  
the factory settings ..... 57

**Connecting the base station to the  
PABX ..... 58**

Dialling modes and recall ..... 58

Saving an access code  
(outside line code) ..... 58

Setting pauses ..... 59

Switching temporarily to  
tone dialling (DTMF) ..... 59

**Appendix ..... 60**

Care ..... 60

Contact with liquid ..... 60

Questions and answers ..... 60

Customer service & product warranty – Aus-  
tralia and New Zealand ..... 61

Accessories ..... 62

Specifications ..... 63

**Notes on the user guide ..... 63**

Example of a menu input ..... 63

Example of multiple line input ..... 64

Writing and editing text ..... 64

**Additional functions via the PC inter-  
face ..... 66**

**Wall-mounting the base station ... 66**

**Index ..... 67**

## Safety precautions

### Warning:

Read the safety precautions and the user guide before use.

Explain their contents and the potential hazards associated with using the telephone to your children.



Only use the mains adapter supplied, as indicated on the underside of the base station or charging cradle.



Fit only the **approved rechargeable battery pack** ( → page 63)! That means never use a conventional (non-rechargeable) battery pack, as this could result in significant health risks and personal injury.

Battery packs should not be disposed of in general household waste. Observe the local waste disposal regulations, which you can find out about by contacting your local authority or the dealer you purchased the product from.



The operation of medical appliances may be affected. Be aware of the technical conditions in your particular environment, e.g. doctor's surgery.



Do not hold the rear of the handset to your ear when it is ringing or when the hands-free function is activated. Otherwise you risk serious and permanent damage to your hearing.

The handset may cause an unpleasant humming noise in hearing aids.



Do not install the base station or charging cradle in bathrooms or shower rooms. The base station and charging cradle are not splashproof ( → page 60).



Do not use your phone in environments with a potential explosion hazard, e.g. paint shops.



If you give your Gigaset to someone else, make sure you also give them the user guide.



Please remove faulty base stations from use or have them repaired by our Service Centre, as they could interfere with other wireless services.



All electrical and electronic equipment must be disposed of separately from general household waste using the sites designated by local authorities.

If a product displays this symbol of a crossed-out rubbish bin, the product is subject to European Directive 2002/96/EC.

The appropriate disposal and separate collection of used equipment serve to prevent potential harm to the environment and to health. They are a precondition for the re-use and recycling of used electrical and electronic equipment.

For further information on disposing of your used equipment, please contact your local authority, your refuse collection service or the dealer you purchased the product from.

**Please note:**

Not all of the functions described in this manual are available in all countries.

**Warning:**

Under power failure conditions, this telephone may not operate. Please ensure that a separate telephone, not dependent on local power, is available for emergency use.

## Gigaset SL370/SL375 – More than just a telephone

---

Your phone, which has a clearly laid out colour display (65K colours) doesn't just offer you the option of sending and receiving SMS messages via the fixed network and of saving up to 250 phone numbers and e-mail addresses (→ page 19) – it can do much more than that:

- ◆ You can reduce the transmission power by activating the eco mode (page 12).
- ◆ You can programme the keys of your phone with important numbers or frequently used functions. The number is then dialled or the function started by simply pressing a key (→ page 47).
- ◆ You can easily make calls using network services (→ page 18).
- ◆ You can designate important people as VIPs so you can tell important calls from the ringer tone (→ page 20).
- ◆ You can assign pictures to your contacts. You can then tell who is calling you from the picture on your handset's display. Precondition: Calling Line Identification (CLIP, page 16).
- ◆ You can store appointments (→ page 53) and anniversaries (→ page 22) in your phone and it will remind you of them in advance.
- ◆ You can use Bluetooth™ for wireless communication with other devices (e.g. headsets) that also use this technology (→ page 54).

**Enjoy using your new telephone!**

## First steps

---

### Pack contents

---

- ◆ one Gigaset SL370/SL375 base station with mains adapter,
- ◆ one Gigaset SL37H handset,
- ◆ one charging cradle with mains adapter,
- ◆ one phone cord,
- ◆ one battery pack,
- ◆ one battery cover,
- ◆ one belt clip,
- ◆ one user guide.

### Installing the base station and charging cradle

---

The base station and charging cradle are designed for use in enclosed dry rooms with a temperature range of +5 °C to +45 °C.

Set up the base station at a central point in the apartment or house.

You can find instructions on how to mount the base station on the wall at the end of this user guide (→ page 74).

#### Please note:

- ◆ Never expose the telephone to heat sources, direct sunlight or other electrical appliances.
- ◆ Protect your Gigaset from moisture, dust, corrosive liquids and vapours.

## Range and reception strength

### Range:

- ◆ Outdoors: up to 300 m
- ◆ Indoors: up to 50 m

The range is reduced when eco mode is on (→ page 12).

### Reception strength:

The display shows the quality of the radio contact between the base station and handset:

- ◆ Good to poor: ▬▬▬ ▬▬▬ ▬▬▬ ▬▬▬
- ◆ No reception: ▬▬▬ flashes

## Connecting the base station

- ▶ **First** connect the mains unit and **then** the phone jack as shown below and place the cable in the cable channels.

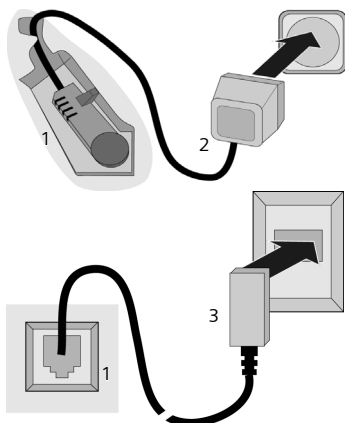

- 1 Underside of the base station (detailed view)
- 2 Mains adapter 240 V
- 3 Phone jack with phone cord

### Please note:

- ◆ The mains adapter must **always be connected**, as the phone will not operate without mains connection.
- ◆ Only use the mains adapter and phone cord **supplied**.

- ◆ If you buy a replacement phone cord, make sure that the phone jack has the correct type of wiring.

### Correct phone jack assignment

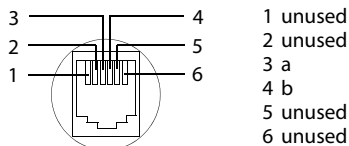

## Setting up the handset for use



The display is protected by a plastic film.  
**Please remove the protective film!**

## Fitting the battery pack

### Warning:

Only use the rechargeable Gigaset Communications GmbH original battery pack (→ page 63)! Never use a conventional (non-rechargeable) battery or other battery types as this could result in significant health risks and personal injury. For example, the batteries could explode. The phone could also malfunction or be damaged as a result of using batteries that are not of the recommended type.

- ▶ With the pins to the front, insert the battery pack into the cavity at an angle from the left.
- ▶ Then press it into the housing from above until the bracket on the side of the battery back snaps securely into the housing.



## First steps

### Please note:

To remove the battery pack, you must first press the bracket on the side.

### Closing the battery cover

- ▶ Align the battery cover parallel to the casing and press down until it clicks into place.



### Attaching the belt clip

There are notches for attaching the belt clip on the side of the handset at the same height as the display.

- ▶ Press the belt clip onto the back of the handset so that the protrusions on the belt clip engage with the notches.

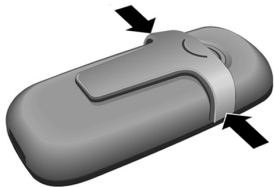

### Opening the battery cover

- ▶ If fitted, remove the belt clip.
- ▶ Lift the device with the keypad facing the palm of your hand.
- ▶ Place the thumb of your other hand on the loudspeaker (a) and use the index finger of the same hand to press the groove at the top of the handset (b).

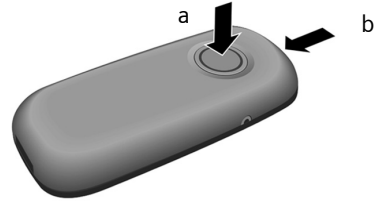

- ▶ Lift the cover.

### Placing the handset in the charging cradle

- ▶ Plug the charging cradle mains adapter into a mains power socket.
- ▶ Place the handset in the charging cradle with the **display facing forward**.

The handset is already registered with the base station at the factory. **INT 1** appears in the display. You do not have to re-register. If, nonetheless, you have to register your handset with the base station, → page 42.

#### Please note:

You can change the name of the handset (→ page 44).

To charge the battery pack, leave the handset in the charging cradle.

#### Please note:

- If the handset has switched itself off because the battery pack is flat and is then placed in the charging cradle, it will switch itself on automatically.
- Only place the handset in the charging cradle that is intended for it.

For questions and problems → page 60.



## Initial charging and discharging of the battery pack

If the handset is activated, the flashing battery icon  in the top right of the display indicates that the battery pack is being charged.

During handset operation, the battery icon indicates the charge status of the battery pack (→ page 1). The correct charge status can only be displayed if the battery pack is first fully charged **and** discharged.

- ▶ To do this, leave the handset in the charging cradle **continuously** for **ten** hours. Your handset need not be switched on for it to charge.
- ▶ Afterwards, remove the handset from the charging cradle and do not put it back again until the battery pack is fully discharged.

### Please note:

After the first battery charge **and** discharge, you may place your handset in the charging cradle after every call.

### Please note:

- ◆ Always repeat the charging and discharging procedure if you remove the battery pack from the handset and insert it again.
- ◆ The battery pack may warm up as it is charging. This is not dangerous.
- ◆ After a time the charge capacity of the battery pack will decrease for technical reasons.

## Setting the date and time

Set the date and time so that the correct date and time can be assigned to incoming calls, and so that the alarm and the calendar can be used.

- ▶ If you have not yet set the date and time, press the display key **Time** to open the input field.

To change the time, open the input field with:

 →  → **Date/Time**

- ▶ Change multiple line input:

### Date:

Enter the day, month and year in 8-digit format.

### Time:

Enter hours and minutes as 4 digits

(e.g.     for 07:15 a.m.)

### Save

Press the display key

## Display in idle status

Once the phone is registered and the time set, the idle display looks as shown here (example). If the answer machine (Gigaset SL375 only) is activated, the answer machine icon  will also be displayed in the header:

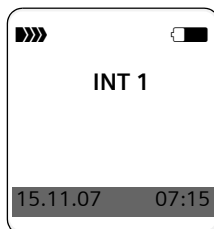

Your answer machine is set with a standard announcement.

### Your phone is now ready for use.



If you have any queries about using your phone, please read the tips on troubleshooting ("Questions and answers, page 60) or contact our customer service department ("Customer service & product warranty – Australia and New Zealand", page 61).

# Operating the handset

## Activating/deactivating the handset



 In idle status, press and hold the end call key (confirmation tone).

## Activating/deactivating the keypad lock

 Press and hold the hash key. You will hear the confirmation tone. The  icon appears in the display when the keypad lock is activated. The keypad lock is deactivated automatically if someone calls you. It is reactivated when the call is finished.





## Control key







Below, the side of the control key that you must press in the respective operating situation is marked in black (top, bottom, right, left, centre), e.g.  for "press right on the control key" or  for "press the centre of the control key".

The control key has a number of different functions:



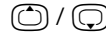

### When the handset is in idle status

-  Open the directory.
-  /  Open the main menu.
-  Open list of handsets.
-  Call up the menu for setting the handset's call volume (→ page 49), ringer tones (→ page 49), advisory tones (→ page 52) and silent alert (→ page 50).



### In the main menu, submenus and lists

-  /  Scroll up/down line by line.
-  Open menu or confirm selection.
-  Go back one menu level or cancel.

### In input fields

You can use the control key to move the cursor up , down , right  or left .

### During an external call

-  Open the directory.
-  Initiate internal consultation call and mute.
-  Change the earpiece volume or handsfree volume.





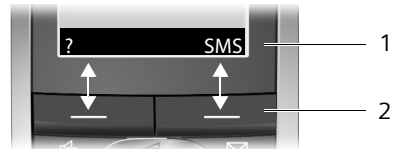

## Display keys



The function of the display keys changes depending on the particular operating situation. Example:



- 1 Current display key functions are shown in the bottom display line.
- 2 Display keys

The most important display icons are:

-  Left display key, as long as it has not been assigned a function (→ page 47).
-  Open the main menu.
-  Open a context-dependent menu.
-  Delete key: deletes one character at a time from right to left.
-  Go back one menu level or cancel operation.
-  Fetch e-mail address from the directory.

-  Copy number into directory.
-  Forward external call to the answer machine (Gigaset SL375 only).
-  Open the last number redial list.

## Reverting to idle status

You can revert to idle status from anywhere in the menu as follows:

- ▶ Press and **hold** the end call key .

Or:

- ▶ Do not press any key: after 10 seconds the display will **automatically** revert to idle status.

Changes that you have not confirmed or saved by pressing **OK**, **Yes**, **Save**, **Send** or **Save Entry** **OK** will be lost.

An example of the display in idle status is shown on page 1.

## Menu guidance

Your telephone's functions are accessed using a menu that has a number of levels.

### Main menu (first menu level)

- ▶ When the handset is in idle status, press  to open the main menu.

The main menu functions are shown in the display as a list with colour icons and names.

To access a function, i.e. to open the corresponding submenu (next menu level):

- ▶ Navigate to the function using the control key . Press the display key **OK**.

## Submenus

The functions in the submenus are displayed as lists.

To access a function:

- ▶ Scroll to the function with the control key  and press **OK**.

Or:

- ▶ Enter the corresponding digit combination (→ page 13).



**Briefly** press the end call key  once to return to the previous menu level / cancel the operation.

## Illustration in the user guide

The operating steps are shown in abbreviated form.



### Example

The illustration:

 →  → Date/Time



means:

 Press the key to display the main menu.

 Use the control key  to scroll through submenu **Settings** and press **OK**.

**Date/Time** Scroll to the function with the control key  and press **OK**.

### Other types of illustrations:

 /  /  etc.

Press the matching key on the handset.

 Enter digits or letters.

**You will find detailed examples of menu entries and multiple line input in the appendix to this user guide, page 63.**

## Correcting incorrect entries

---

You can correct incorrect characters in the text by navigating to the incorrect entry using the control key. You can then:

- ◆ press **⬅** to delete the character to the left of the cursor
- ◆ insert characters to the left of the cursor
- ◆ overwrite the character (flashing) when entering the time and date etc.

## ECO DECT



---

ECO DECT reduces power consumption by using a power supply with low power consumption and also reduces the transmission power of the base station.

You can set this **manually** with your handset. It can be used by several handsets at the same time.

Your handset also reduces the transmission power depending on the distance to the base station.

### Activating/deactivating eco mode:

 →  → Base → Add. Features  
→ Eco Mode

**OK** Press the display key  
( = activated).

When eco mode is activated, the  icon is displayed at the top of the screen.

#### Please note:

- Activating eco mode reduces the range of the base station.
- Eco mode and any repeater support (→ page 57) cancel each other out, i.e. both functions cannot be used at the same time.
- If external handsets (GAP) and handsets from earlier Gigaset versions are used, your handset will **not** automatically reduce the transmission power to the base station.

# Menu tree

Instead of scrolling to locate a menu function, you can select a function more quickly by opening the menu and keying in a digit combination (or shortcut).

**Example:**  **8**  **2**  **2**  **1**  for "Set ringer tone for external calls".

With the telephone in **idle status**, press  (open main menu):

**1**    **SMS** 

**You have activated a SMS mailbox (general or private) without a PIN**

1-1	New SMS	( → page 29)
1-2	Incoming 0	( → page 29)
1-3	Outgoing 0	( → page 27)

**You have activated a SMS mailbox with a PIN or 2-3 mailboxes**

1-1	Mailbox	1-1-1	New SMS	( → page 27)
		1-1-2	Incoming 0	( → page 29)
		1-1-3	Outgoing 0	( → page 27)
1-2 to 1-4	Mailbox 1 Mailbox 2 Mailbox 3	1-2-1 to 1-4-1	New SMS	( → page 27)
		1-2-2 to 1-4-2	Incoming 0	( → page 29)
		1-2-3 to 1-4-3	Outgoing 0	( → page 27)
1-5	SMS Service			( → page 32)
1-6	Settings	1-6-1	Service Centres	( → page 32)
		1-6-2	SMS Mailboxes	( → page 31)
		1-6-3	Notify Number	( → page 30)
		1-6-4	Notify Type	( → page 31)
		1-6-6	Subscribe to SMS	( → page 27)

**2**    **Sel. Services** 

**3**    **Calls List**                    ( → page 24)

**4**    **Add. Features** 

4-3	Room Monitor			( → page 45)
4-4	Walky-Talky			( → page 46)
4-5	Data Transfer	4-5-2	Bluetooth	( → page 54)
		4-5-3	Directory	( → page 21)

## Menu tree

4-7 Missed Alarms ( → page 54)

5 Alarm Clock  ( → page 52)

6 Calendar  ( → page 53)

7 Resource Dir. 

7-1 Screensavers ( → page 51)

7-2 Caller Pictures ( → page 51)

7-3 Sounds ( → page 51)

7-4 Capacity ( → page 51)

8 Settings 

8-1 Date/Time ( → page 9)

8-2 Audio Settings 8-2-1 Handset Volume ( → page 49)

8-2-2 Ringer Settings ( → page 50)

8-2-3 Advisory Tones ( → page 52)

8-2-4 Silent Alert ( → page 50)

8-3 Display 8-3-1 Screen Saver ( → page 48)

8-3-2 Colour Scheme ( → page 48)

8-3-3 Contrast ( → page 48)

8-3-4 Backlight ( → page 49)

8-4 Handset 8-4-1 Language ( → page 48)

8-4-2 Auto Answer ( → page 49)

8-4-3 Register H/Set ( → page 42)

8-4-4 Select Base ( → page 42)

8-4-5 Area Codes ( → page 56)

8-4-6 Reset Handset ( → page 56)

8-5 Base 8-5-2 Music on hold ( → page 57)

8-5-3 System PIN ( → page 57)

8-5-4 Base Reset ( → page 57)

8-5-5 Add. Features (page 12, page 44, page 58)

8-5-6 Preselection ( → page 25)

8-5-7 Calls List Type ( → page 24)

8-6	Voice Mail	8-6-1	Set Key 1	( → page 41)
-----	------------	-------	-----------	--------------

Gigaset SL375 only:

8-6-2	Ans Machine	( → page 35)
8-6-3	Call Screening	( → page 38)
8-6-4	Announcements	( → page 35)
8-6-5	Message Length	( → page 39)
8-6-6	Record Quality	( → page 39)
8-6-7	Ring Delay	( → page 39)

## Making calls

---

### Making an external call

---

External calls are calls using the public telephone network.



Enter the number and press the talk key.

Or:



Press and **hold** the talk key and then enter the number.

You can cancel the dialling operation with the end call key.

You are shown the duration of the call while the call is in progress.

#### Please note:

Dialling using the directory, the call-by-call list (page 1, page 19) or the calls and last number redial list (page 24/page 22) saves you from having to re-enter numbers and network provider prefixes ("call-by-call numbers").

### Continuing a call on a Bluetooth headset

**Precondition:** Bluetooth is activated; a connection has been established between Bluetooth headset and the handset (→ page 54).

Press the talk key on the Bluetooth headset; it may take up to 5 seconds to establish a connection to the handset.

For further details on your headset, see the user guide issued with it.

### Ending a call

---



Press the end call key.

### Accepting a call

---

The handset indicates an incoming call in three ways: by ringing, by a display on the screen and by the flashing handsfree key.



You can accept the call by:

- ▶ Pressing the talk key.
- ▶ Pressing the handsfree key.
- ▶ Gigaset SL370: Press the display key **Accept**.
- ▶ Gigaset SL375: Press the display key **o o** to divert the call to the answer machine (page 38).

If the handset is in the charging cradle and the **Auto Answer** function is activated (→ page 49), the handset will take a call automatically when you lift it out of the cradle.

If the ringer tone is intrusive, press the **Silence** display key. You can take the call as long as it is displayed on the screen.

### Answering a call on a Bluetooth headset

**Precondition:** Bluetooth is activated; a connection has been established between the Bluetooth headset and the handset (→ page 54).

Only press the talk key on the headset when the headset rings; it can take up to 5 seconds to establish a connection with the handset.

For further details on your headset, see the user guide issued with it.

### Calling Line Identification

---

When you receive a call, the caller's number and/or name is displayed on the screen if the following conditions are met:

- ◆ Your network provider supports CLIP, CLI and CNIP.
  - CLI (Calling Line Identification): the caller's number is transmitted.
  - CLIP (Calling Line Identification Presentation): the caller's number is displayed.
  - CNIP (Calling Name Identification Presentation): the caller's name is displayed.
- ◆ You have arranged CLIP or CNIP with your network provider.



- ◆ The caller has arranged CLI with the network provider.

## Call display with CLIP/CLI

If the number of the caller is saved in your directory, you will see their name, and if you have assigned a CLIP picture to that caller, this will also be displayed.

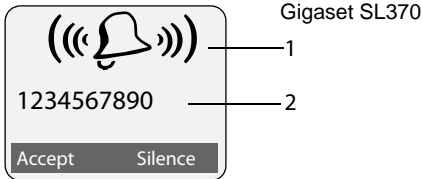

or

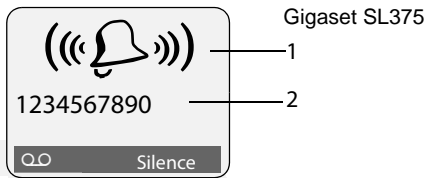

- 1 Ringer tone icon
- 2 Number or name of caller

The following is displayed in place of the number:

- ◆ **External**, if no number is transmitted.
- ◆ **Withheld**, if the caller has withheld Calling Line Identification.
- ◆ **Unavailable**, if the caller has not arranged Calling Line Identification.

## Display with CNIP

If you have CNIP, then the name (town) that is registered with your network provider for that calling number will **also** be displayed. If the number of the caller is stored in your directory, the CNIP display is replaced by the corresponding directory entry.

1234567890	1
Anna Fielding, London	2

- 1 Caller's number
- 2 Name and town

The display shows:



- ◆ **External**, if no number is transmitted.
- ◆ **Withheld**, if the caller has withheld Calling Line Identification.
- ◆ **Unavailable**, if the caller has not arranged Calling Line Identification.

## Handsfree talking

In handsfree mode, instead of holding the handset to your ear you can put it down, for example on the table in front of you, to allow others to participate in the call.

## Activating/deactivating handsfree mode

### Activating while dialling

  Enter the number and press the handsfree key.



- ▶ You should inform your caller before you use the handsfree function so that they know someone else is listening.

### Switching between earpiece and handsfree mode

 Press the handsfree key.

During a call and when listening to the answer machine (Gigaset SL375 only), switch handsfree on or off.

If you wish to place the handset in the charging cradle during a call:

- ▶ Press and hold the handsfree key  while placing the handset in the base station. If the handsfree key  does not light up, press the key again.

For how to adjust the handsfree volume  
→ page 49.

## Muting

You can deactivate the microphone in your handset during an external call. The other party hears hold music.

 Press the control key on the left to mute the handset.

 Press the display key to reactivate the microphone.

You can switch the hold music on and off (→ page 57).

## Making calls using network services

---

Network services are functions that your network provider makes available to you. You have to request these services from your network provider.

- ▶ **If you require assistance, please contact your network provider.**

## Using the directory and lists

---

The options are:

- ◆ Directory
- ◆ Call-by-call list
- ◆ Last number redial list
- ◆ SMS list
- ◆ Call history
- ◆ Answer machine list  
(Gigaset SL375 only)

You can store a total of 250 entries in the directory and call-by-call list.

You create the directory and call-by-call list for your own individual handset. You can also send lists/entries to other handsets (→ page 21).

### Directory/call-by-call list

#### Please note:

For quick access to a number from the directory or the call-by-call list (quick dial), you can assign the number to a key.

### Directory

---

In the **directory** you can store

- ◆ Up to three numbers and associated first names and surnames
- ◆ VIP designation and VIP ringer tone (optional)
- ◆ E-mail address (optional)
- ◆ CLIP pictures (optional)
- ◆ Anniversaries with reminder
  - ▶ With the handset in idle status, open the directory by pressing the  key.

#### Length of the entries (directory)

3 numbers: each max. 32 digits

First name and surname:  
each max. 16 characters

E-mail address: max. 60 characters

### Call-by-call list

---

The **call-by-call list** is used to store the access codes for network providers (so-called "Call-by-call numbers").

- ▶ Open the call-by-call list in idle status by pressing the  key.

#### Length of entries

Number: max. 32 digits

Name: max. 16 characters

### Storing a number in the directory

---

#### → New Entry

- ▶ Change multiple line input:

#### First Name / Surname:

Enter a name in at least one of the fields.

#### Phone (Home) / Phone (Office) / Phone (Mobile)

Enter a number in at least one of the fields.

#### E-mail

Enter e-mail address.

#### Annivers.:

Select **On** or **Off**.

With setting **On**:

enter **Anniversary (Date)** and **Annivers. (Time)** (→ page 22) and select reminder type: **Annivers. (Signal)**.

#### Caller Picture

If required, select a picture to be displayed when the caller calls (→ page 51).  
Precondition: Calling Line Identification (CLIP).

- ▶ Save changes: (→ page 64).

### Storing a number in the call-by-call list

---

#### → New Entry

- ▶ Change multiple line input:

#### Name:

Enter name.

#### Number:

Enter number.

### Order of directory/call-by-call list entries

---

Directory entries are generally sorted alphabetically by surname. Spaces and digits take first priority. If only the first name was entered in the directory, this is incorporated into the sort order instead of the surname.



The sort order is as follows:

1. Space
2. Digits (0–9)
3. Letters (alphabetical)
4. Other characters



To get round the alphabetical order of the entries, insert a space or a digit in front of the first letter of the surname. These entries will then move to the beginning of the directory.

### Selecting entries in the directory and call-by-call list

---

 /  Open directory or call-by-call list.

You have the following options:

- ◆ Use  to scroll through the entries until the required name is selected.
- ◆ Enter the first character of the name (in the directory: first character of the surname or of the first name if **only** the first name has been entered), or scroll to the entry using .

### Dialling with the directory/call-by-call list

---

 /  →  (select entry)

 Press the talk key. The number is dialled.

### Managing entries in the directory/call-by-call lists

---

 /  →  (select entry)

#### Viewing entries

**View** Press the display key. The entry is displayed.  
Back with **OK**.

#### Editing entries

**View** **Edit** Press display keys one after the other.

- Carry out changes and save.

#### Using other functions

 /  →  (select entry)  
→ **Options** (open menu)

The following functions can be selected with :

#### Display Number

To edit or add to a saved number, or to save it as a new entry, press  after the number is displayed.

#### Edit Entry

Edit selected entry.

#### Delete Entry

Delete selected entry.

#### VIP Entry (directory only)

Mark a directory entry as a **VIP** (Very Important Person) and assign a specific ringer tone to it. You can then recognise important calls from the ringer tone.

**Precondition:** Calling Line Identification (→ page 16).

#### Copy Entry

Send a single entry to a handset (→ page 21).

#### Delete List

Delete **all** entries in the directory/call-by-call list.

#### Copy List

Send complete list to a handset (→ page 21).

## Available Memory

Display the available entries in the directory and call-by-call list (→ page 19).



## Using quick dial keys

- ▶ Press and hold the required quick dial key (→ page 47).

## Sending the directory/call-by-call list to another handset

### Preconditions:

- ◆ The sending and receiving handsets must both be registered on the same base station.
- ◆ The other handset and the base station can send and receive directory entries.

 /  →  (select entry) → **Options** (open menu) → **Copy Entry / Copy List** → **to Internal**



 Select the internal number of the receiving handset and press **OK**.

You can transfer several individual entries one after another by responding to **Copy next entry?** with **Yes**.

A successful transfer is confirmed by a message and confirmation tone on the receiving handset.

### Please note:

You can also send the complete **directory** via data transfer, without opening the directory:



 →  → **Data Transfer** → **Directory**

### Please note:

- ◆ Entries with identical numbers are not overwritten on the receiving handset.
- ◆ The transfer is cancelled if the phone rings or if the memory of the receiving handset is full.

## Transferring the directory as a vCard with Bluetooth

In Bluetooth mode (→ page 54) you can transfer directory entries in vCard format, e.g. to exchange entries with your mobile.

 →  (select entry) → **Options** (open menu) → **Copy Entry / Copy List** → **vCard via Bluetooth**

The list of "Known Devices" (→ page 55) is displayed.

 Select device and press **OK**.

## Receiving a vCard with Bluetooth

If a device from the "Known Devices" list (→ page 55) sends a vCard to your handset, this occurs automatically and you are informed about it via the display.

If the sending device does not appear in the list, you will be asked on the display to enter the device PIN for the sending device:

 Enter the PIN for the **sending** Bluetooth device and press **OK**.

The transferred vCard is available as a directory entry.

## Copying a displayed number to the directory

You can copy numbers to the directory that are displayed in a list, e.g. the call history or the last number redial list, in a SMS or during a call to the directory.

If you have CNIP, the first 16 characters of the transmitted name are copied to the **Name** line.

A number is displayed:

**Options** → **Copy to Directory**



- ▶ Complete the entry, → page 19.

Gigaset SL375: The message playback is interrupted during the number transfer from the answer machine list.

### Copying a number or e-mail address from the directory

---

In many operating situations, you can open the directory to copy a number or e-mail address, for example. Your handset need not be in idle status.

- ▶ Depending on the operating situation, open the directory with  or  or  **Directory**.

 Select an entry (→ page 20).

### Saving an anniversary in the directory

---

For each number in the directory, you can save an anniversary and specify a time at which a reminder call should be made on the anniversary (delivery status: **Annivers.: Off**).

Anniversaries are automatically recorded in the calendar (→ page 53).

 →  (select entry; page 20)

**View** **Edit** Press display keys one after the other.

 Scroll to the **Annivers.:** line.

 Select **On**.

- ▶ Change multiple line input:

#### Anniversary (Date)

Enter day/month/year in 8-digit format.

#### Annivers. (Time)

Enter the hour/minute for the reminder call in 4-digit format.

#### Annivers. (Signal)

Select the type of signal for the reminder.

- ▶ Save changes: (→ page 64).

### Deactivating anniversaries

 →  (select entry; page 20)

**View** **Edit** Press display keys one after the other.

 Scroll to the **Annivers.:** line.

 Select **Off**.

**Save** Press the display key.

### Reminder call on an anniversary

A reminder call is signalled on the handset using the selected ringer tone.

You now have the following options:

**SMS** Write a SMS.

**OFF** Press the display key to acknowledge and end the reminder call.

### Viewing missed anniversaries

In idle status, you are reminded of an elapsed and unacknowledged anniversary by the **one-off** display of **Appoint.**

- ▶ View appointment:

**Appoint.** Press the display key.

You now have the following options:

**SMS** Write a SMS.

**Delete** Delete reminder.  
After deleting, press the  or **Go Back** display key:  
Back to idle status, **Appoint.** is no longer displayed.

You can also view missed anniversaries afterwards (→ page 54).

### Last number redial list

---

The last number redial list contains the twenty numbers last dialled with the handset (max. 32 digits). If one of the numbers is in the directory or in the call-by-call list, the corresponding name will be displayed.

### Manual last number redial

---

 Press the key **briefly**.

 Select entry.

 Press the talk key again.  
The number is dialled.

When a name is displayed, you can display the corresponding phone number by pressing the **View** display key.

## Managing entries in the last number redial list

 Press the key **briefly**.

 Select entry.

**Options**  Open menu.

The following functions can be selected with



### Copy to Directory

Copy an entry to the directory (page 19).

### Automatic Redial

The selected number is automatically dialled at fixed intervals (at least every 20 seconds). The handsfree key flashes and "open listening" is activated.

- Party answers: press the talk key . The function is ended.
- Party does not answer: the call is terminated after approx. 30 seconds. The function is ended after pressing any key or after ten unsuccessful attempts.

**Display Number** (as in the directory, page 20)

**Delete Entry** (as in the directory, page 20)

**Delete List** (as in the directory, page 20)

## Opening lists with the message key

You can use the message key  to open the following list selection:



### ◆ SMS list

If **several** mailboxes are set up (→ page 31), several lists are displayed.

- ◆ Answer machine list (Gigaset SL375 only) or Network mailbox, if your network provider supports this function and the network mailbox is set for fast access (→ page 41).

### ◆ Call history

An advisory tone sounds as soon as a **new message** arrives in a list. The message key  flashes (it goes off when the key is pressed). In **idle status**, the display shows an icon for the new message:



Icon	New message...
	... in the answer machine list (Gigaset SL375 only) or on the network mailbox
	... in the call history
	... in SMS list

The number of new entries is shown beneath the corresponding icon.

### List selection

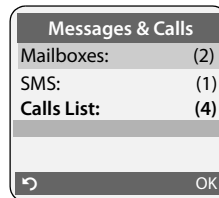
If you press the message key , only the lists that contain messages are shown (exception: network mailbox). Lists with new messages are identified in **bold**:



Select a list with . To open, press  or **OK**.

If only one list contains entries, no list selection is offered and the relevant list is displayed immediately.

### Incoming SMS message list

All received SMS messages are saved in the incoming message list, page 29.

### Call history

---

**Precondition:** Calling Line Identification (CLIP, page 16)

Depending on the type of list set, the call history contains

- ◆ accepted calls (☑)
- ◆ missed calls
- ◆ calls recorded by the answer machine (∞, Gigaset SL375 only)



Depending on the type of list set, all numbers of the last 30 incoming calls are stored or only the missed calls.

You can also call up the call history via the menu:

 → Calls List

### Setting the call history type

---

 →  → Base → Calls List Type

**Missed Calls / All Calls**

Select and press **OK** (☑ = on).

 Press and **hold** (idle status).

The call history entries are retained when you change the list type.

### List entry

---

New messages are on top.

Example of list entries:

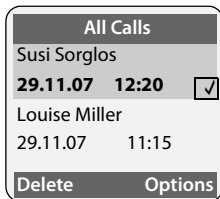

- ◆ List type (in header)
- ◆ Status of entry  
**Bold:** new entry
- ◆ Number or name of caller  
You can add the caller's number to the directory (→ page 21).
- ◆ Date and time of call (if set, page 9)

- ◆ Type of entry:
  - accepted calls (☑)
  - missed calls
  - calls recorded by the answer machine (∞, Gigaset SL375 only)

Pressing the display key **Delete** deletes the marked entry.

After pressing the display key **Options** you can select more functions with .

#### Copy to Directory

Copying a displayed number to the directory.

#### Delete List

Delete complete list.

#### Information

See following section "Displaying CNIP information".

When you quit the call history, all entries are set to the status "old", i.e. the next time you call the list up they will no longer be shown in bold.

### Answer machine list (Gigaset SL375 only)

---

You can use the **answer machine list** to listen to the messages that are on the answer machine.

### Displaying CNIP information

---

If you have CNIP, you can display the name and town that is registered with your network provider for this number.

You have selected a list entry.

**Options** Open menu.

**Information** Select and press **OK**.

If the name and town are not shown, it means that the caller has not requested Calling Line Identification or that Calling Line Identification has been withheld.

Press **OK** to return to the list.



## Making cost-effective calls

---

Sign up with a network provider who offers particularly low-cost call rates (call-by-call). You can manage the numbers in the call-by-call list.

### Linking call-by-call numbers with one number

---

You can insert the dialling code of a network provider ahead of the number ("linking").



Open call-by-call list.



Select entry (call-by-call number).

#### Options

Press the display key.

#### Display Number

Select and press **OK**.



Enter number or select number from the directory ( → page 22).



Press the talk key. Both numbers are dialled.

### Automatic network provider preselection (Preselection)

---

You can specify a call-by-call number (preselection number), which is **automatically** placed in front of numbers when you dial them.

- ◆ The "**with preselection**" list contains the "rule" for dialling code numbers or the first digits of dialling code numbers with which you wish the preselection number to be used.

- ◆ The "**without preselection**" list contains the "exception to the rule".

Example:

You have entered 08 for "with preselection". Now all numbers that start with 08 will be dialled with preselection.



If, for example, you want 081 to still be dialled without preselection, enter 081 for "without preselection".

When dialling, the **first** digits of the selected numbers are compared with both lists after the talk/handsfree key is pressed:

- ◆ The preselection number is not prefixed if the dialled number
  - **does not** match any entries in the two lists
  - matches an entry in the "**without preselection**" list
- ◆ The preselection number is prefixed if the first digits of the dialled number match with **only one** entry in the list "**with preselection**".

### Saving preselection numbers

---

 →  → Base → Preselection  
→ Preselect No.



Enter or change the preselection number (call-by-call number).

#### Save

Press the display key.





Press and **hold** (idle status).

### Save or change entries in the preselection lists

---

Each of the two lists can contain 20 entries, each with 6 digits.

Numbers may be prefixed according to the country in the "**with preselection**" list. This means e.g. that all national calls or calls to the mobile network are **automatically** linked to the preselection number you have stored previously.

 →  → **Base** → **Preselection**  
→ **With Preselect / Without Preselect.**

 Select entry.

**Edit** Press the display key.

 Enter or edit first digits of number.

**Save** Press the display key.

 Press and **hold** (idle status).

### Temporarily cancelling preselection

---

 (press and hold) → **Options**  
→ **Aut Preselect off**

### Permanently deactivating preselection

- ▶ Delete the preselection number ( → page 25).

## SMS (text messages)

Your unit is supplied ready for sending SMS messages immediately.

### Preconditions:

- ◆ Calling Line Identification is enabled for your phone line.
- ◆ Your network provider supports SMS in the fixed network (information on this can be obtained from your network provider).
- ◆ You are registered with your service provider to send and receive SMS.

SMS messages are exchanged between SMS centres operated by service providers. You must enter the SMS centre through which you wish to send and receive SMS messages into your phone. You can receive SMS messages from **every** SMS centre that is entered, provided you have registered with your service provider.

Your SMS messages are sent via the **Service Centr.** that is shown as the **active send service centre**. However, you can activate any other SMS centre as the active send service centre to send a current message (→ page 32).

If no SMS Service Centre is entered, the SMS menu only contains the entry **Settings**. Enter a SMS Service Centre (→ page 32).

Information on writing a SMS can be found in the appendix:

- ◆ For how to enter text, → page 64.
- ◆ Writing using the predictive text tool EATONI, → page 65.

### Rules

- ◆ a SMS can be up to 612 characters.
- ◆ If there are more than 160 characters, the SMS is sent as a **linked SMS** (up to 4 messages with 153 characters each).

### Please note:

- ◆ If your phone is connected to a PABX, please read page 33.
- ◆ To receive SMS messages you must be registered with your service provider.

## Registering with the registration wizard

The first time you press the **SMS** display key you will be asked whether you wish to register automatically with all entered SMS centres (→ page 32). Confirm with **Yes** or refuse with **No** to abort automatic registration. You can now receive SMS messages from all SMS centres whose numbers you have entered.



You can call up automatic registration thereafter via the menu:

 →  → **Settings**  
→ **Subscribe to SMS**

The registration wizard does not support setting up personal mailboxes (→ page 31).

## Writing/sending a SMS

### Writing a SMS

 → 

**Mailbox 2** Select mailbox if necessary and press **OK**.



Enter mailbox PIN if necessary and press **OK**.

**New SMS** Select and press **OK**.



Write a SMS.

### Please note:

- Instructions on entering text can be found on page 64, and on writing with EATONI predictive text on page 65.
- EATONI is activated as a default setting. Activating/deactivating EATONI page 65.

## SMS (text messages)

### Sending a SMS



Press the talk key

or:

#### Options

Press the display key.

#### Send

Select and press **OK**.

#### SMS

Select and press **OK**.



Select number with area code (even if you are in that area) from the directory or call-by-call list, or enter number directly. For SMS to a SMS mailbox: add the mailbox ID to the **end** of the number.

#### Send

Press the display key. The SMS is sent.

#### Please note:

- If you are interrupted by an external call while writing a SMS, the text is automatically saved in the draft message list.
- If the memory is full, or if the SMS function on the base station is being used by another handset, the operation is cancelled. An appropriate message appears in the display. Delete SMS messages you no longer require or send the SMS later.

### Setting input language

- ▶ You are writing a SMS (→ page 27).

#### Options

Press the display key.

### Select Language

Select and press **OK**.



Select input language and press **OK**.



Press the end call key **briefly** twice to return to the text panel.

The input language setting only applies to the current SMS.

### Draft message list

You can save a SMS in the draft message list and edit and send it later.

### Saving a SMS in the draft message list

- ▶ You are writing a SMS (→ page 27).

#### Options

Press the display key.

**Save Entry** Select and press **OK**.

### Opening the draft message list



→ → (mailbox, mailbox PIN)

→ **Outgoing** (3)

The first list entry is displayed, e.g.:

1234567890  
21.11.07 09:45

### Reading or deleting individual SMS messages

- ▶ Open the draft message list and then:



Select SMS.

#### Read

Press the display key. The entry will be displayed. Scroll line by line using .

Or delete the SMS with

**Options Delete Entry OK**.

### Writing/changing a SMS

- ▶ You are reading a SMS in the draft message list.

#### Options

Open menu.

You have the following options:

#### New SMS

Write a new SMS and then send (→ page 28) or save it.

#### Edit

Edit the text of the saved SMS and then send (→ page 28).

#### Character Set

Text is shown in the selected character set.

### Deleting draft message list

- ▶ Open the draft message list and then:

#### Options

Open menu.

#### Delete all

Select, press **OK** and confirm with **Yes**. The list is cleared.





Press and **hold** (idle status).

## Sending SMS messages to an e-mail address

If your service provider supports the **SMS as e-mail** feature, you can also send your SMS messages to e-mail addresses.

The e-mail address must be at the beginning of the text. You must send the SMS to the e-mail service of your SMS send centre.

 →  → (mailbox, mailbox PIN)  
→ **New SMS**

 / 

Load the e-mail address from the directory or enter it directly. End the entry with a space or colon (depending on the service provider).



**Options**

Enter the SMS text.

Press the display key.

**Send**

Select and press **OK**.

**E-mail**

Select and press **OK**. If the number of the e-mail service is not entered (→ page 32), enter the number of the e-mail service.

**Send**

Press the display key.

## Sending SMS messages as a fax

You can also send a SMS to a fax machine.

**Precondition:** Your network provider supports this feature.

▶ You are writing a SMS (→ page 27).

**Options**

Press the display key.

**Send**

Select and press **OK**.

**Fax**

Select and press **OK**.



Select number from the directory or enter directly. Enter the number with dialling code (even if you are in the same area).

**Send**

Press the display key.

## Receiving a SMS

All received SMS messages are saved in the incoming message list. Linked SMS messages are displayed as **one** message. If this is too long or is not transferred completely, it is split into individual messages. Since a SMS remains in the list even after it has been read, you should **regularly delete SMS messages from the list**.



The display tells you if the SMS memory is full.

- ▶ Deleting SMS messages you no longer require (→ page 30).

## Incoming message list

The incoming message list contains:

- ◆ All received SMS messages, starting with the most recent.
- ◆ SMS messages that could not be sent due to an error.

New SMS messages are signalled on all Gigaset SL37H handsets by the  icon in the display, the flashing message key  and an advisory tone.

## Opening the incoming message list with the key

 Press.

Select mailbox if necessary and enter mailbox PIN.

The incoming message list is displayed as follows (example):

```
SMS:      (2)  — 1
           — 2
```

- 1 **bold:** number of new entries
- regular:** number of read entries
- 2 Name of mailbox, here: general mailbox



Open list with **OK**.

An entry in the list is displayed e.g. as follows:

```
1234567890
21.11.05 09:45
```

## SMS (text messages)

### Opening the incoming message list via the SMS menu

-  →  → (mailbox, mailbox PIN)
- Incoming (2)

### Reading or deleting individual SMS messages

- ▶ Open the incoming message list.
- ▶ Continue as described in "Reading or deleting individual SMS messages", page 28.

After you have read a new SMS, it is given the status "Old" (is no longer shown in bold).

### Deleting the incoming message list

All new and old SMS messages in the list are deleted.

- ▶ Open the incoming message list.

**Options** Open menu.

- ▶ To continue, see "Deleting draft message list", page 28.

### Replying to or forwarding SMS messages

---

- ▶ Read the SMS ( → page 30):

**Options** Press the display key.

You have the following options:

#### Reply

Write and send a reply SMS directly ( → page 27).

#### Edit

Edit the text in the SMS and then send it ( → page 28).

### Forwarding a SMS

- ▶ You are reading a SMS ( → page 30):

**Options** Press the display key.

**Forward** Select and press **OK**. For further information, → page 28.

### Adding a number to the directory

---

#### Adding the sender's number

- ▶ Open incoming message list and select entry ( → page 29).

**Options** Press the display key. For further information, → page 21.

#### Please note:

- You can create a special directory for SMS messages within your main directory by putting a star (\*) before the names.
- An attached mailbox identifier is added to the directory.

### Copying/dialling numbers from a SMS text

- ▶ Read SMS ( → page 30) and scroll to the telephone number.

The digits are reverse-highlighted.

 Press the display key. For further information, → page 21.

Or:

 Press the talk key to dial the number.

If you wish to use the number to send a SMS:

- ▶ Save the number with the local area code (dialling code) in the directory.

### Changing the character set

- ▶ Read the SMS ( → page 30):

**Options** Press the display key.

#### Character Set

Text is shown in the selected character set.

### Notification by SMS

---

You can have yourself notified about missed calls or new answer machine messages (Gigaset SL375 only).

**Precondition:** For missed calls, the caller's number (CLI) must have been transmitted.

Notification is sent to your mobile phone or another phone with SMS functionality.

You only need to set the phone number to which notification should be sent (notification number) and the notification type.

#### Storing the notification number

 →  → **Settings** → **Notify Number**



Enter the number to which the SMS should be sent.



Press the display key.



Press and **hold** (idle status).

**Warning:**

Do **not** enter your own fixed network number for the notification of missed calls. This can lead to chargeable endless looping.

**Setting the notification type**

→ → **Settings** → **Notify Type**

▶ Change multiple line input if necessary:

**Missed Calls:**

Set **On** if you require SMS notification.

**Ans Machine:**

(Gigaset SL375 only)

Set **On** if you require SMS notification.

▶ Save changes ( → page 64).

**SMS mailboxes**

The **General Mailbox** is the default setting. Anyone can access this mailbox and it cannot be protected by a PIN. You can additionally set up three **personal mailboxes** and protect these with a **PIN**. Each mailbox is identified by a name and a "Mailbox ID" (a kind of extension number).

**Please note:**

- ◆ If you operate a number of devices (base stations) with SMS functionality on a single phone line, then each SMS mailbox ID may only occur once. In this case you must also change the preset ID of the general mailbox ("0").
- ◆ You can only use personal mailboxes if your service provider supports this function. You can tell whether this is the case by the addition of a star (\*) to the number of a (preset) SMS centre.
- ◆ If you have forgotten your mailbox PIN, you can reset it by restoring the base station's default settings. This will **delete all SMS messages from all mailboxes**.

**Setting up and changing a personal mailbox****Setting up a personal mailbox**

→ → **Settings** → **SMS Mailboxes**



Select a mailbox, e.g. **Mailbox 2** and press **OK**.

▶ Change multiple line input:

**On/Off:**

Activate or deactivate mailbox.

**ID:**

Select mailbox ID (0–9). You can only select the available numbers.

**Protection:**

Activate/deactivate PIN protection.

**PIN**

If necessary, enter 4-digit PIN.

▶ Save changes ( → page 64).

Active mailboxes are marked with  in the mailbox list. They are shown in the SMS list and can, if necessary, be displayed by pressing the message key

**Deactivating a mailbox**

▶ Set **On/Off:** to **Off**. Confirm message with **Yes** if necessary.

All SMS messages saved in this mailbox will be deleted.

**Deactivating PIN protection**

▶ Set **Protection:** to **Off**.

The mailbox PIN is reset to "0000".

**Changing the name of a mailbox**

→ → **Settings** → **SMS Mailboxes**



(select mailbox)



Press the display key.



Enter new name.





Press the display key.



Press and **hold** (idle status).

## SMS (text messages)

### Changing a mailbox's PIN and ID

 →  → Settings → SMS Mailboxes  
→  (select mailbox)

 Enter mailbox PIN if necessary  
und press **OK**.

▶ Set ID; Protection: and PIN ( → page 31).

### Sending a SMS to a personal mailbox

To send a SMS to a personal mailbox, the sender must know your ID and enter it after your number.

▶ You can send your SMS contact a SMS via your personal mailbox.

Your SMS contact will receive your SMS number with current ID and can save it in their directory. If the ID is invalid, the SMS will not be delivered.

## Setting SMS centres

### Entering/changing SMS centres

▶ You should find out about the services and special functions offered by your service provider **before you make a new application** and/or before you delete pre-configured call numbers.

 →  → Settings → Service Centres

 Select SMS centre (e.g. Service Centr. 1) and press **OK**.

▶ Change multiple line input:

#### Active Send:

Select **Yes** if SMS messages are to be sent via the SMS centre. For the SMS centres 2 to 4, the setting only applies to the next SMS.

#### SMS:

Press the display key **Edit**. Enter the number of the SMS service and insert a star if your service provider supports personal mailboxes.

#### E-mail:

Press the display key **Edit**. Enter the number of the e-mail service.

▶ Save changes ( → page 64).

#### Please note:

Ask your service provider for details on how to enter service numbers if you wish to use personal mailboxes (precondition: your service provider supports this function).

### Sending a SMS through another SMS centre

▶ Activate the SMS centre (2 to 4) as active send service centre.

▶ Send the SMS.

This setting only applies to the next SMS to be sent. Thereafter, the setting returns to **Service Centr. 1**.

## SMS info services

You can have your service provider send you certain information (e.g. weather forecasts or lottery numbers) via SMS. A total of up to 10 info services can be stored. You can obtain information about the info services available and their costs from your service provider.

### Setting up/ordering an info service

#### Ordering an info service

 →  → SMS Service

 Select info service.

**Send** Press the display key.



## Setting up an info service

- ▶ Select an empty entry, delete beforehand if necessary. Then:

**Edit**

Press the display key.



If necessary, enter code, designation and destination number.

**Save**

Press the display key.

## Editing the entry of an info service

- ▶ Select the info service (see above). Then:

**Options**

Opening menu.

**Edit Entry**

Select and press **OK**.



If necessary, change the code, designation, or destination number.

**Save**

Press the display key.

## Deleting an info service

- ▶ Select the info service (see above). Then:

**Options**

Open menu.

**Delete Entry** Select and press **OK**.

## SMS on a PABX

- ◆ You can only receive a SMS when the **Calling Line Identification is forwarded to the extension of the PABX (CLIP)**. The CLIP of the phone number for the SMS centre is evaluated in your **Gigaset**.
- ◆ If required, you must prefix the number for the SMS centre with the access code (depending on your PABX).  
If in doubt, test your PABX, e.g. by sending a SMS to your own number, once with and once without the access code.
- ◆ When you send SMS messages, your sender number may be sent without your extension number. In this case the recipient cannot reply to you directly.

Sending and receiving SMS messages **on ISDN PABXs** is only possible via the MSN number assigned to your base station.

## Activating/deactivating the SMS function

If you deactivate the SMS function, you cannot send or receive any SMS messages with your phone.

The settings which you have made for sending and receiving SMS messages (e.g. the call numbers of the SMS centres) and the entries in the incoming and draft message lists are saved even after you switch off your phone.



Open menu.



Enter the digits.



**OK**

Deactivate SMS function.

Or:



**OK**

Activate SMS function (default setting).

## SMS troubleshooting

### Error codes when sending

EO	Calling Line Identification permanently withheld (CLIR) or Calling Line Identification not activated.
FE	Error occurred during SMS transfer.
FD	Connection to SMS centre failed, see self-help.

### Self-help with errors

The following table lists error situations and possible causes and provides notes on troubleshooting.

<p>You cannot send messages.</p> <ol style="list-style-type: none"> <li>You have not requested the CLIP service (Calling Line Identification Presentation). <ul style="list-style-type: none"> <li>Ask your service provider to enable this service.</li> </ul> </li> <li>SMS message transmission has been interrupted (e.g. by a call). <ul style="list-style-type: none"> <li>Re-send the SMS.</li> </ul> </li> <li>Network provider does not support this feature.</li> <li>No number or an invalid number is entered for the SMS centre set as the active send service centre. <ul style="list-style-type: none"> <li>Enter the number ( → page 32).</li> </ul> </li> </ol>
<p>You receive an incomplete SMS.</p> <ol style="list-style-type: none"> <li>Your phone's memory is full. <ul style="list-style-type: none"> <li>Delete old SMS messages ( → page 30).</li> </ul> </li> <li>The service provider has not yet sent the rest of the SMS.</li> </ol>
<p>You have stopped receiving SMS messages.</p> <ol style="list-style-type: none"> <li>You have changed the ID of your mailbox. <ul style="list-style-type: none"> <li>Give your SMS contacts your new ID or undo the change ( → page 31).</li> </ul> </li> <li>You have not activated your mailbox. <ul style="list-style-type: none"> <li>Activate your mailbox ( → page 31).</li> </ul> </li> <li>Call diversion is activated with <b>When: All Calls</b> or the call diversion <b>All Calls</b> is activated for the network mailbox. <ul style="list-style-type: none"> <li>Change the call diversion.</li> </ul> </li> </ol>

The message is played back.

- The "display call number" service is not activated.
  - Ask your service provider to activate this function (chargeable).
- Your mobile phone operator and your fixed network SMS service provider have not agreed on a co-operation.
  - Obtain information from your fixed network SMS service provider.
- Your terminal is recorded by your SMS provider as having no fixed network SMS functionality, i.e. you are no longer registered with the provider.
  - Start the registration wizard for automatic registration ( → page 27).
  - Obtain information from your fixed network SMS service provider.
  - Have the device (re-)registered to receive SMS messages.

Messages are only received during the day.

- The terminal is recorded in your SMS provider's database as having no fixed network SMS functionality, i.e. you are no longer registered with the provider.
- Start the registration wizard for automatic registration ( → page 27).
  - Obtain information from your fixed network SMS service provider.
  - Have the device (re-)registered to receive SMS messages.

## Answer machine operation (Gigaset SL375 only)

---

You can operate the answer machine that is integrated in the base station via the handset or via remote operation (other phone/mobile phone).

### Announcement mode

You can use the answer machine in two different modes.

- ◆ In **Ans. & Record** mode, the caller hears the announcement and can then leave a message.
- ◆ In **Announce Only** mode, the caller hears your announcement but cannot leave a message.

### Operation via the handset

---

The handset loudspeaker activates **automatically** if you receive an acoustic prompt or message while operating. You can switch it off with the handsfree key .

### Activating/deactivating the answer machine

---



 →  → Voice Mail → Ans Machine  
( = on)

When you switch the answer machine on, the remaining memory time is announced. If the time has not yet been set (→ page 9), an appropriate announcement is made. The  icon appears in the display.

The phone is supplied with pre-recorded announcements for answer and record mode and for announce only mode. If a personal announcement has not been recorded, the relevant pre-recorded announcement is used.

### Recording a personal announcement/announce only

---



 →  → Voice Mail  
→ Announcements → Record  
Announce / Record Anc Only

**OK** Press the display key to start the recording.

You hear the ready tone (short tone).

- ▶ Now speak your announcement (at least 3 sec.).

**End** Press the display key to end the recording.

Cancel the recording with  or   
Restart the recording with **OK**.



After recording, the announcement is played back for you to check. You can re-record the announcement with **New**.

### Please note:

- ◆ Recording ends automatically if the maximum recording time of 170 seconds is exceeded or there is a break in speech for more than 2 seconds.
- ◆ If you cancel the recording, the pre-recorded announcement will be used again.
- ◆ If the answer machine's memory is full, it will switch to **Announce Only** mode.
  - ▶ Delete old messages and the answer machine will automatically switch back to **Ans. & Record** mode. Repeat recording if required.

### Playing back announcements

---

 →  → Voice Mail  
→ Announcements → Play Announce /  
Play Anc Only

If you have not recorded a personal announcement, the relevant pre-recorded announcement is played.

## Answer machine operation (Gigaset SL375 only)



Record a new announcement while playing back announcement:

**New** Press the display key.

- ◆ If the answer machine's memory is full, it will switch to **Announce Only** mode.
  - ▶ Delete old messages and the answer machine will automatically switch back to **Ans. & Record** mode. Repeat recording if required.

### Deleting announcements/ announce only

---

 →  → **Voice Mail**  
→ **Announcements**  
→ **Del Announce/Del Anc Only**

**Yes** Press the display key to confirm the prompt.



 Press and **hold** (idle status).

Once you have deleted your announcement, the relevant pre-recorded announcement will be used again.

### Selecting announcement mode

---

You can choose between **Ans. & Record** and **Announce Only**.

 →  → **Voice Mail**  
→ **Announcements** → **Set Ans. Mode**  
→ **Ans. & Record / Announce Only**  
( = on)

 Press and **hold** (idle status).

The selected mode is saved even after the answer machine is deactivated.

If the memory for messages is full in **Ans. & Record** mode, the answer machine will switch to the **Announce Only** mode and you will receive an instruction to delete old messages.



- ▶ Delete old messages.

The answer machine **automatically** switches back to the set mode once deletion is complete. You can then reselect the required recording mode.

### Setting "answer and record" or "announce only" by toggling

You can use the **Ans Mode Time** setting to change over the announcement mode for a specific period.

**Example:** **Ans. & Record** mode is set. If you activate **Ans Mode Time** and set a period (e.g. 18.00 to 08.00) the answer machine switches to **Announce Only** mode for this period. Outside this period (08.01 to 17.59), **Ans. & Record** mode is active.

 →  → **Voice Mail**  
→ **Announcements** → **Set Ans. Mode**  
→ **Ans Mode Time** ( = on)  
▶ Change multiple line input:

**From:**

Enter hours/minutes for the start of the period in 4-digit format.

**Until:**

Enter hours/minutes for the end of the period in 4-digit format.

**Activation:**

Select **On** or **Off**.

- ▶ Save changes with **Save**.

If the memory for messages is full and **Activation: On** has been selected, saving is interrupted and you will receive an instruction to delete old messages.

- ▶ Delete old messages and repeat the setting.



As soon as you change the announcement mode (→ page 36), the **Ans Mode Time** function is automatically deactivated.

### Playing back messages

---

The date and time of each message is logged (provided this has been set, page 9) and displayed during the playback. If Calling Line Identification is activated, the caller's number or name is displayed. If the caller's number is stored in the directory, their name is displayed.

## Playing back new messages

New messages that have not yet been heard are indicated by the  icon in the display and by the  key flashing on the handset.

 Press the message key.

**Ans M.:** Select and press **OK**.

An announcement informs you if there are new or old messages.

If there are new messages, playback then begins with the first new message. After the last new message you will hear the end tone and an announcement about how much recording time remains.

If the message has been saved with the date and time you will hear an appropriate announcement before playback begins.



## Playing back old messages



You can listen to old messages if there are no more new messages. Begin playback as described under "Listening to new messages".



After the entry time and date have been played back (after approx. 3 seconds) a new message assumes the status "old".

## Stopping and controlling playback

During message playback:

 Pause playback. Press  again to resume.

 or  Skip to the start of the current message.  
Press twice: skip back to the previous message.

 or  Go to the next message.  
Press twice: skip to the next but one message.

If playback is interrupted for over a minute, the answer machine returns to idle status.

## Reading CNIP information of a message

▶ Please read page 24.

## Marking a message as "new"

A previously played back "old" message is displayed as a "new" message again.

### During message playback:

 Press the star key.

An announcement informs you of the message's new status.

**Or:**

**Options** Open menu.

### Mark as New

Select and press **OK**.

Playback of the current message is cancelled. Playback of next message starts, if applicable.

The  key on the handset flashes.

## Adding the telephone number of a message to the directory

See "Copying a displayed number to the directory", page 21.

## Deleting messages

---

You can delete old messages either all together or individually.

### Deleting all old messages

During playback or pause:

**Options** Press the display key.

### Del All Old Msgs

Select and press **OK**.

**Yes** Press the display key to confirm the prompt.

### Deleting individual old messages

During playback or pause:

**Delete** Press the display key.

## Picking up a call from the answer machine

---

You can pick up a call while the answer machine is recording it or is being operated via remote operation:



Press the talk or display key.

Recording stops and you can speak to the caller.

If 2 seconds of the call have already been recorded when you pick it up, the call will be displayed as a new message. The  key on the handset flashes.

You can accept the call even if it is not signalled on the handset.

## Diverting an external call to the answer machine

---

You can divert an incoming external call to the answer machine even if it is switched off.

**Precondition:** Sufficient storage space is available on the answer machine.

An external call is signalled on the handset:



Press the display key.

The answer machine starts immediately in recording mode and records the call. The set time for the call acceptance (→ page 39) is ignored.

## Activating/deactivating two-way recording

---

You can record an **external** call with the answer machine.

- ▶ Inform the caller that the call is being recorded.



Open menu.

### Two Way Record

Select and press **OK**.

The two-way recording is indicated on the display by an advisory text and is added to the answer machine list as a new message.



Press the display key to stop the two-way recording.

The maximum recording time depends on the available memory of the answer machine. If the memory is full you will hear an end tone, the recording is aborted, and the call recorded up to that point is listed in the answer machine list as a new message. If the answer machine was in **Ans. & Record** mode, it will switch to the **Announce Only** mode. You will receive an instruction to delete old messages.

- ▶ Delete old messages.

The answer machine **automatically** switches back to the set mode once deletion is complete.



## Activating/deactivating call screening

---

During recording of a message you can listen in via the loudspeaker of registered handsets.

## Permanently activating/deactivating call screening

---

 →  → Voice Mail → Call Screening → Handset ( = on)



Press and **hold** (idle status).

You can switch off the **Call Screening** function on the handset during the recording.

## Switching off call screening for the current recording

---



Press the end call key.

## Setting up the answer machine

The answer machine has already been pre-set at the factory. Make individual settings using the handset.

### Call acceptance/charge saving function for remote operation

You can set when you want the answer machine to accept a call.

The options are: **0 sec.**, after **10 sec.**, **18 sec.** or **30 sec.** and the cost-saving setting **Automatic**.

In **Automatic** mode, the following applies for call acceptance:

- ◆ If there are no new messages, the answer machine accepts a call after 18 seconds.
- ◆ If new messages are present, the answer machine accepts a call after **10 seconds**.

When operating remotely you can tell after approx. 15 seconds that there are no new messages (otherwise the answer machine would already have accepted your call). There will be no call charges if you hang up now.

 →  → **Voice Mail** → **Ring Delay**

 Select **0 sec. / 10 sec. / 18 sec. / 30 sec. / Automatic**.

 Press the display key.

 Press and **hold** (idle status).

### Setting the recording time

You can set the maximum recording time of a message. The options are: **1, 2, 3 mins** or **Maximum**.

 →  → **Voice Mail** → **Message Length**

 Select recording time.

 Press the display key.

### Setting the recording quality

Set the quality you require for your recordings. The options are: **Standard, High, Excellent**. If the quality is higher, the maximum recording time is reduced.

 →  → **Voice Mail** → **Record Quality**

 Select the recording quality.

 Press the display key.

### Resetting fast access for the answer machine using key 1

By factory default, the integrated answer machine is set for fast access. However, if you have set the network mailbox for fast access (→ page 41), you can reset this setting.

 →  → **Voice Mail** → **Set Key 1**

**Answer Machine / Network Mailb.**

Select and press **OK**.

 Press and **hold** (idle status).

After you have selected the network mailbox or the answer machine, press and **hold** key . You will be connected directly.

The setting for fast access applies to all Gigaset SL37H handsets.

### Operating when on the move (remote control)

You can check or activate the answer machine from any other telephone (e.g. hotel, pay phone) or initiate ringback from the answer machine with a SMS.

#### Preconditions:

- ◆ You have set a system PIN other than 0000 (→ page 57).
- ◆ The phone you are using for remote operation has touch tone dialling (DTMF), i.e. you hear different tones when you press the keys. Alternatively, you can use a code transmitter (available from your mobile phone retailer).

## Calling the answer machine and playing back messages

---



Dial your own number.



When you hear your announcement, press **9** and enter the system PIN.

You will be informed whether any new messages have been recorded. The messages are now played back. You can now operate the answer machine with the keypad.

## Operating the answer machine via the keypad

The following keys are used for operation:

**1**

Skip to the start of the current message.  
Press twice: skip back to the previous message.

**2**

Stop playback. Press again to resume.

**3**

Go to the next message.

**\***

Mark message as "new".

**0**

Delete current message.

## Activating the answer machine

---

- ▶ Phone home and let the phone ring until you hear: "Please enter PIN".



Enter system PIN.

Your answer machine is activated. It tells you how much memory time is left.

The messages are now played back.

The answer machine cannot be deactivated remotely.

## Initiating ringback from the answer machine with SMS and listening to messages

---

**Precondition:** You must have stored a notification number ( → page 30).

You can use the telephone (mobile phone or any other device with SMS functionality) for which you have stored the notification number in your phone to send a SMS to your answer machine when you are away from home. It will then call you back. The message playback begins when you accept the call and press any key.

The SMS must contain the following:

\*<System PIN>\*<Ringback number>\*

The ringback number is optional.

Examples:

\*4711\* or \*4711\*089123456\*

If a ringback number is entered, it is dialled; otherwise the notification number is dialled.

You can now operate the answer machine via the keypad, as described in the previous sections.



## Using the network mailbox

---

The network mailbox is your network provider's answer machine within the network. You cannot use the network mailbox unless you have **requested** it from your network provider.

### Configuring fast access for the network mailbox

---

With fast access, you can dial the network mailbox or the integrated answer machine (Gigaset SL375 only) directly.

Gigaset SL370: Fast access is set for the network mailbox. You only need to enter the number of the network mailbox.

Gigaset SL375: The integrated answer machine is set for fast access. Instead of using this, you can specify the network mailbox, such as the T-NetBox provided by T-Com. Ask your network provider about this.

### Configuring fast access for the network mailbox and entering the network mailbox number

 →  → Voice Mail → Set Key 1

#### Network Mailb.

Select and press **OK** ( = on).



Enter the number for the network mailbox.

**Save**

Press the display key.



Press and **hold** (idle status).

The setting for fast access applies to all Gigaset SL37H handsets.

### Calling the network mailbox



Press and **hold**. You are connected straight to the network mailbox.



Press handsfree key  if required. You will hear the network mailbox announcement.

### Viewing the network mailbox report

---

When a message is recorded, you receive a call from the network mailbox. If you have requested Calling Line Identification, the network mailbox number will be displayed. If you take the call, the new messages are played back. If you do not take the call, the network mailbox number will be saved in the missed calls list and the message key flashes (→ page 23).

## Using several handsets

---

### Registering handsets

---

You can register up to six handsets to your base station.

A Gigaset SL37H handset can be registered to up to four base stations.

### Manually registering the Gigaset SL37H to Gigaset SL370/SL375

---

You must initiate handset registration on the handset and on the base station.

Once it has been registered, the handset returns to idle status. The internal number of the handset appears in the display, e.g. INT 1. If it does not, repeat the procedure.

#### On the handset

 →  → **Handset** → **Register H/Set**

 Select base station, e.g. **Base 1** and press **OK**.

 Enter the system PIN of the base station (the default is 0000) and press **OK**. The following flashes in the display, e.g. **Base 1**.

#### On the base station

Within 60 sec. press and **hold** the registration/paging key on the base station (page 1) (approx. 3 sec.).

### Registering other handsets

---

You can register other Gigaset handsets and handsets for other devices with GAP functionality as follows.

#### On the handset

▶ Start to register the handset as described in its user guide.

#### On the base station

Press and **hold** the registration/paging key on the base station (page 1) (approx. 3 sec.).

## De-registering handsets

---

You can de-register any other registered handset from any registered Gigaset SL37H handset.

 Open list of internal parties. The handset you are currently using is indicated by < .

 Select the internal party you wish to de-register.

**Options** Open menu.

**De-reg. H/Set No.** Select and press **OK**.

 Enter the current system PIN and press **OK**.

**Yes** Press the display key.

## Locating a handset ("paging")

---

You can locate your handset using the base station.

▶ **Briefly** press the registration/paging key on the base station (page 1).

▶ All handsets will ring simultaneously ("paging"), even if the ringer tones are switched off.

### Ending paging

▶ **Briefly** press the registration/paging key on the base station or press the talk key  on the handset.

## Changing the base station

---

If your handset is registered to more than one base station, you can set it to a particular base station or to the base station that has the best reception (**Best Base**).

 →  → **Handset** → **Select Base**

 Select one of the registered base stations or **Best Base** and press **OK**.

## Making internal calls

---

Internal calls to other handsets registered on the same base station are free.

### Calling a specific handset



Initiate internal call.



Enter the number of the handset.

Or:



Initiate internal call.



Select handset.



Press the talk key.

### Calling all handsets ("group call")



Initiate internal call.



Press the star key. All handsets are called.

### Ending a call



Press the end call key.

## Transferring a call to another handset

---

You can transfer an external call to another handset (connect).



Open list of handsets.  
The external participant hears hold music if activated (→ page 57).



Select a handset or **Call All** and press **OK**.

When the internal participant answers:

- ▶ If necessary announce the external call.



Press the end call key.

The external call is transferred to the other handset.

If the internal participant does **not** answer or the line is busy, press the display key **End**, to return to the external call.

When transferring a call you can also press the end call key before the internal participant answers.

Then, if the internal participant does not answer or the line is busy, the call will automatically return to you (the display will show **Recall**).

## Internal consultation/conference calls

---

When you are speaking to an **external** participant, you can call an **internal** participant at the same time for consultation or hold a conference call between all 3 participants.

You are conducting an **external** call.



Open list of handsets.  
The external participant hears hold music if activated (→ page 57).



Select handset and press **OK**.  
You are connected with the internal participant.

Either:



Press the display key.  
You are reconnected with the external participant.

Or:

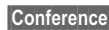

Press the display key.  
All 3 participants are connected with each other.

### Ending a conference call



Press the end call key.

If an **internal** participant presses the end call key , the other handset remains connected to the external participant.

## Accepting/rejecting call waiting

---

If you receive an **external** call during an **internal** call, you will hear the call waiting tone (short tone). The caller's number or name will appear in the display if Calling Line Identification is enabled.

### Ending an internal call, accepting an external call



Press the display key.

## Using several handsets

The internal call is **ended**. You are connected to the external caller.

### Rejecting the external call

 Press the display key.

The call waiting tone is turned off.



You remain connected with the internal participant. The ringer tone can still be heard on other registered handsets.

## Listening in to an external call

**Precondition:** The **Listening In** function must be activated.

You are conducting an external call. An internal participant can listen in on this call and take part in the conversation. All the participants are made aware of the "listening in" by a signal tone.

### Activating/deactivating internal listening-in

 →  → **Base** → **Add. Features** → **Listening In**

Press **OK** to switch the function on or off ( = on).

 Press and **hold** (idle status).

### Internal listening-in

The line is engaged with an external call. Your screen will display information to that effect. You want to listen in to the external call.

 Press and **hold** the talk key.

You are linked into the call. All participants hear a signal tone. During this time, this handset displays the **Conference** message and it is not possible to dial another number from this handset.

### Ending listening in

 Press the end call key.

All participants hear a signal tone.

If the **first** internal participant presses the end call key , the handset that has "listened in" remains connected to the external participant.

## Changing the name of a handset

The names "INT 1", "INT 2" etc. are assigned automatically at registration. You can change these names. The name must be no more than 10 characters. The changed name is displayed in every handset's list.



Open list of handsets. Your own handset is indicated by <.



Select handset.

**Edit**

Press the display key.



Enter name.

**Save**

Press the display key.

## Changing a handset's internal number

A handset is **automatically** assigned the lowest free number on registration. If all slots are occupied, number 6 is overwritten if this handset is in idle status. You can change the internal number of all registered handsets (1–6).



Open list of handsets. Your own handset is indicated by <.

**Options**

Open menu.

**Edit H/Set No.**

Select and press **OK**. The list of handsets is displayed.



The current number flashes. Select a handset.



Enter the new internal number (1–6). The handset's old number is overwritten.

**Save**

Press the display key to save the input.



Press and **hold** (idle status).

You will hear the error tone (descending tone sequence) if you assign an internal number twice.

▶ Repeat the procedure with a free number.

## Using a handset as a room monitor

If the room monitor is activated, a previously stored destination number is called as soon as a set noise level is reached. You can store an internal or external number in your handset as the destination number.

The room monitor call to an external number stops after around 90 seconds. The room monitor call to an internal number (handset) stops after approx. 3 minutes (depending on the base station). While the room monitor is activated, all keys are locked except the end call key. The handset's speaker is muted.

When the room monitor is activated, incoming calls to the handset are indicated **without a ringer tone** and are only shown on the screen. The display and keypad are not illuminated and advisory tones are also turned off.



If you accept an incoming call, the room monitor mode is suspended for the duration of the call, but the function **remains** activated.

If you deactivate then reactivate the handset, the room monitor mode remains activated.

### Caution!

- You should always check the operation of the room monitor before use. For example, test its sensitivity. Check the connection if you are diverting the room monitor to an outside number.
- When the function is switched on the handset's operating time is severely reduced. If necessary, place the handset in the charging cradle. This ensures that the batteries do not run down.
- Ideally the handset should be positioned 1 to 2 metres away from the baby. The microphone must be directed towards the baby.
- The connection to which the room monitor is diverted must not be blocked by an activated answer machine.

## Activating the room monitor and entering the number to be called

 →  → Room Monitor

- ▶ Change multiple line input:

### Room M.:





Select **On** to activate.

### Call to:

#### External number:

Select the number from the directory (press display key ) or enter it directly. Only **the last 4 digits** are displayed.

#### Internal number:

 → INT →  →  (select handset or **Call All** if all registered handsets are to be called) → .

### Level:

Set noise level sensitivity (**Low** or **High**).

- ▶ Press  to save the settings.

### Changing the set destination number

---

 →  → **Room Monitor**

 Scroll to the **Call to:** line.

 or **Delete**



Delete existing number.

- ▶ Enter and save number as described in "Activating the room monitor and entering the number to be called" ( → page 45).

### Deactivating the room monitor remotely

---

**Preconditions:** The phone must support touch tone dialling and the room monitor should be set for an external destination number.

- ▶ Accept the call from the room monitor and press keys  .

The room monitor function will deactivate after the call ends. There will be no further room monitor calls. The other room monitor settings (e.g. no ringer tone) on the handset will remain activated until you press the display key **OFF** on the handset.

To reactivate the room function with the same phone number:

- ▶ Turn on the activation again and save with **Save** ( → page 45).



### Walky-talky mode

---

Walky-talky mode allows two handsets to communicate with each other, both inside and outside the range of the base station to which the handsets are registered.

Handsets that are to communicate with each other using walky-talky mode must meet one of the following conditions:

- ◆ The handsets are all registered to the same base station.
- ◆ The handsets are set to **Best Base** or are not yet registered.

In walky-talky mode, if you press the talk key  or the handsfree key , the call will go to all handsets that are in walky-talky mode. The connection is made with the first handset to accept the walky-talky call.

#### Please note:

- ◆ The maximum range outdoors is 300 m.
- ◆ Handsets that are in walky-talky mode are not available for phone calls.
- ◆ The handset operating times are greatly curtailed.

### Activating/deactivating walky-talky mode

---

 →  → **Walky-Talky**

Use **OK** to activate walky-talky mode.

You can now:

**OFF** Press the display key. Walky-talky mode is switched off.

or

 Press the display key to open the menu.

The following functions can be selected with :

#### Audio Settings

You can set **Ringer Settings** ( → page 50) and **Advisory Tones** ( → page 52) for walky-talky mode.

#### Room Monitor

You can use the handset in walky-talky mode as a room monitor.

### Using a handset in walky-talky mode as a room monitor

---

 → **Room Monitor**

- ▶ Change multiple line input:

#### Room M.:

Select **On** to activate.

#### Level:

Set noise level sensitivity (**Low** or **High**).

- ▶ Save changes ( → page 64).

The room monitor will use all the handsets that are in walky-talky mode.

Switch the room monitor off by pressing the display key **OFF** on the handset that was used to activate the room monitor. The handset reverts to normal walky-talky mode.

## Handset settings

---

Your handset is preconfigured, but you can change these settings to suit your individual requirements.

### Shortcuts for functions and numbers

---

You can assign the left display key and each of the digit keys **0 +** and **2 abc** to **key 9** a number or a function. The right display key has a function pre-selected by default. You can change the assigned function.

The number is then dialled or the function started by simply pressing a key.

#### Assigning a digit key/left display key

---

**Precondition:** The digit key or the left display key has not yet been assigned a number or a function.

- ▶ Press the display key **?** or press and **hold** the digit key.

The list of possible key assignments is opened. The following can be selected:

##### Quick Dial / Call-by-Call

Assign key to a number from the directory or call-by-call list.

The directory or call-by-call list is opened.

- ▶ Select an entry and press **OK**.

If you delete or edit an entry in the directory or call-by-call list, this has no effect on the assignment to the digit/display key.

##### Room Monitor

Assign key to the menu for setting and activating the room monitor (→ page 45).

##### Alarm Clock

Assign key to the menu for setting and activating the alarm clock (→ page 52).

##### Calendar

Open calendar/enter new appointment.

##### Bluetooth

Assign the Bluetooth menu to a key.

##### More Features...

More features are available:

##### INT

Internal calls (→ page 43).

##### SMS

Assign the menu for SMS functions to a key (→ page 27).

##### SMS Service

Assign key with the menu for ordering info services (→ page 32).

##### SMS Notific.

Assign key with the menu for activating SMS notification (page 30).

If the left display key has been assigned a shortcut, the selected function or name of the phone number in the directory or call-by-call list is displayed (abbreviated if necessary) in the bottom display line via the display key.

#### Starting the function, dialling the number

---

If the handset is in idle status, press and **hold** the digit key or press the display key **briefly**.

Depending on the key assignment:

- ◆ Numbers are dialled directly.
- ◆ The function menu is opened.

## Handset settings

### Changing key assignments

---

#### Display key

- ▶ Press and **hold** the left or right display key.

The list of possible key assignments is opened.

- ▶ Proceed as is described when first assigning the key with a shortcut (→ page 47).

#### Digit key

- ▶ Press the digit key **briefly**.

**Change** Press the display key. The list of possible key assignments is displayed.

- ▶ Proceed as is described when first assigning the key with a shortcut (→ page 47).

### Changing the display language

---

You can view the display texts in different languages.

 →  → **Handset** → **Language**

The current language is indicated by .

 Select a language and press **OK**.

 Press and **hold** (idle status).

If you accidentally choose a language you do not understand:



     
Press keys in sequence.

 Select the correct language and press **OK**.

### Setting the display



---

You have a choice of four colour schemes and several different contrasts.

 →  → **Display**

#### Colour Scheme

Select and press **OK**.

 Select a colour scheme and press **OK** ( = current colour).

 Press **briefly**.

**Contrast** Select and press **OK**.

 Select contrast.

**Save** Press the display key.

 Press and **hold** (idle status).

### Setting the screensaver

---

You can set a picture from the Resource Dir. (page 51) to be displayed as a screensaver when the handset is in idle status. This will replace the idle status display. It may conceal the date, time and name.

The screensaver is not displayed in certain situations, e.g. during a call or if the handset is de-registered.

If a screensaver is activated, the **Screen Saver** menu option is marked with .

 →  → **Display** → **Screen Saver**

The current setting is displayed.

- ▶ Change multiple line input:



#### Activation:

Select **On** (screensaver is displayed) or **Off** (no screensaver).

#### Selection:

If required, change the screensaver (see below).

- ▶ Save changes: (→ page 64).

If the screensaver conceals the display, **briefly** press  or  to show the idle display with time and date.

### Changing the screensaver

---

 →  → **Display** → **Screen Saver**

 Scroll to the **Selection** line.

**View** Press the display key. The active screensaver is displayed.

 Select screensaver and press **Change**.

- ▶ Save changes: (→ page 64).



## Setting the display backlight

Regardless of whether or not the handset is in the charging cradle, you can activate or deactivate the backlighting. If the base station is switched on, the display is permanently dimmed.

 →  → **Display** → **Backlight**

The current setting is displayed.

▶ Change multiple line input:

### In Charger

Select **On** or **Off**.

### Without Charger

Select **On** or **Off**.

#### Please note:

With the **On** setting, the standby time of the handset can be significantly reduced.

#### Save



Press the display key.



Press and **hold** (idle status).

## Activating/deactivating auto answer

If you activate this function, when you receive a call you can simply lift the handset out of the charging cradle without having to press the talk key .

 →  → **Handset**

### Auto Answer

Select and press **OK** ( = on).



Press and **hold** (idle status).

## Changing the handsfree/earpiece volume

You can set the loudspeaker volume for handsfree talking to five different levels and the earpiece volume to three different levels.

In idle status:

 → **Handset Volume**



Set the earpiece volume.



Scroll to the **Speaker**: line.



Set the speaker volume.

#### Save

Press display key if necessary to save the setting.

Setting the volume during a call:



Press the control key.



Set the volume.

The setting will automatically be saved after approx. 3 seconds or press the display key

#### Save.

If  is assigned with another function:

#### Options

Open menu.

**Volume** Select and press **OK**.



Configure setting (see above).

#### Please note:

You can also set the call volume, the ringer tones, advisory tones and the silent alert via the menu (→ page 14).

## Changing ringer tones

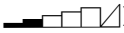
### ◆ Volume:

You can choose between five volumes (1–5; e.g. volume 2 = ) and the "Crescendo" ring (6; volume increases with each ring = .

### ◆ Ringer tones:

You can select various ringer tones, melodies or any sound from My stuff (→ page 51).

You can set different ringer tones for the following functions:

- ◆ **Ext. Calls:** for external calls
- ◆ **Internal Calls:** for internal calls
- ◆ **Appointments:** for set appointments (→ page 53)
- ◆ **All:** the same ringer tone for all functions

## Handset settings

### Settings for individual functions

---

Set the volume and melody depending on the type of signalling required. You can activate the time control for external calls to regulate the volume of a call (e.g. quieter at night-time than in daytime).

In idle status:



→ **Ringer Settings**



Select setting, e.g. Ext. Calls and press **OK**.



Set volume (1–6).



Scroll to the next line.



Select melody.



**Save** Press the display key to save the setting.

### Additionally for external calls:



Press display key.

► Change multiple line input:

#### Time control :

Select **On** or **Off**.

#### From:

Enter the start of the period in 4-digit format.

#### Until:

Enter the end of the period in 4-digit format.

#### Volume:

Set the volume (1–6).

### Same ringer tone for all functions

---

In idle status:



→ **Ringer Settings** → **All**

► Set volume and ringer tone (see "Settings for individual functions").



Press the display key to confirm the prompt.



Press and **hold** (idle status).

#### Please note:

You can also set the call volume, the ringer tones, advisory tones and the silent alert via the menu (→ page 14).

### Activating/deactivating the ringer tone

---

You can deactivate the ringer tone on your handset before you answer a call or when the handset is in idle status; the ringer tone can be deactivated permanently or just for the current call. The ringer tone cannot be reactivated while an external call is in progress.

#### Deactivating the ringer tone permanently



Press and **hold** the star key.

The  icon appears in the display when in idle status.

#### Reactivating the ringer tone



Press and **hold** the star key.

#### Deactivating the ringer tone for the current call



Press the display key.

### Activating/deactivating the alert tone

---

In place of the ringer tone you can activate an alert tone. When you get a call, you will hear a **short tone** ("Beep") instead of the ringer tone.



Press and **hold** the star key and **within 3 seconds**:



Press the display key. A call will now be signalled by **one** short alert tone. You will now see  in the display.

#### Silent alert

---

Incoming calls and other messages are indicated by vibration.

In idle status:



→ **Silent Alert**

Activate or deactivate with **OK**





( = activated).

#### Please note:

You can also set the call volume, the ringer tones, advisory tones and the silent alert via the menu (→ page 14).

## My stuff

My stuff on the handset manages sounds, which you can use as ringer tones, and pictures (CLIP pictures and screensavers), which you can use as caller pictures or as screen-savers. Precondition: Calling Line Identification (CLIP). My stuff can manage the following media types:



Icon	Sound	Format
	Ringer tones	Standard
	Monophonic	Standard
	Polyphonic	.mid
	Picture (CLIP picture, screen-saver)	BMP (128 x 128 or 128 x 64 pixels)



The icon is displayed in front of the name in My stuff. Various mono- and polyphonic sounds and pictures are preconfigured on your handset.

You can listen to the available sounds and view the pictures.

You can download pictures from a PC (→ page 66). If there is not enough memory available, you must first delete one or more pictures. The pre-configured pictures are labelled with . You cannot rename or delete them.

### Playing back sounds/viewing CLIP pictures

 →  → Screensavers / Caller Pictures / Sounds (select entry)

**Play / View**  Press the display key. Sounds are played back or pictures are displayed. Press the  key to switch between entries.

**End /**  Press the display key. Playback of the sound or the display of the picture ends.

While you are playing back sounds, you can also interrupt playback with the  key.

Press and **hold** (idle status).





If you have saved a picture in an invalid data format, you will see an error message after selecting the entry. Cancel the operation with  Delete the picture with **Delete**.

### Sounds: setting the volume

During playback:

**Volume**  Press the display key.

 Set volume.

**Save**  Press the display key.

### Renaming/deleting a picture

You have selected an entry.

**Options**  Open menu.

If a picture cannot be deleted () , these options are not available. Depending on the situation, you can select the following functions:

#### Delete Entry

The selected entry is deleted.

#### Delete List



All entries in the list that can be deleted are deleted.

#### Rename

Change the name (max. 16 characters) and press **Save**. The entry is stored with the new name.

### Checking the memory

You can check how much memory is available for screensavers and CLIP pictures.

 →  → Capacity

 Back: press the display key.

## Activating/deactivating advisory tones

---

Your handset uses "advisory tones" to tell you about different activities and statuses. The following advisory tones can be activated and deactivated independently of each other:

- ◆ **Key click:** every key press is confirmed.
- ◆ **Advisory tones:**
  - **Confirmation tone** (ascending tone sequence): at the end of an entry/setting and when a SMS or a new entry arrives in the answer machine list or call history
  - **Error tone** (descending tone sequence): when you make an incorrect entry
  - **Menu end tone:** when scrolling at the end of a menu
- ◆ **Battery low tone:** the battery pack requires charging.

In idle status:

 → **Advisory Tones**

- ▶ Change multiple line input:

### Key Tones:

Select **On** or **Off**.

### Confirm.:

Select **On** or **Off**.

### Battery:

Select **On**, **Off** or **In Call**. The battery warning tone is only activated/deactivated and only sounds during a call.

- ▶ Save changes: ( → page 64).

You cannot deactivate the confirmation tone for placing the handset in the base station.

### Please note:

You can also set the call volume, the ringer tones, advisory tones and the silent alert via the menu ( → page 14).

## Setting the alarm clock

---

**Precondition:** The date and time have already been set ( → page 9).

### Activating/deactivating the alarm clock and setting the wake-up time

---

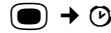

- ▶ Change multiple line input:

### Activation:

Select **On** or **Off**.

### Time:

Enter the wake-up time in 4-digit format.

### Occurance:

Select **Daily** or **Monday-Friday**.

### Volume:

Set the volume (1–6).

### Melody:

Select melody.

- ▶ Save changes: ( → page 64).

You will see the  icon.

A wake-up call with selected ringer tone ( → page 49) is signalled on the handset. The wake-up call sounds for 60 seconds.  is shown in the display. If no key is pressed, the wake-up call is repeated twice at five minute intervals and then switched off.

During a call, the wake-up call is signalled by a short tone.

### Deactivating the wake-up call/ repeating after a pause (snooze mode)

---

**Precondition:** A wake-up call is sounding.

**OFF**

Press the display key. The wake-up call is deactivated.

or

**Snooze**

Press the display key or any key. The wake-up call is deactivated and then repeated after 5 minutes. After the second repetition the wake-up call is deactivated completely.

## Setting an appointment (calendar)

---

You can have your handset remind you of up to 30 appointments (volume and melody, → page 49).

### Saving an appointment

---

**Precondition:** The date and time have already been set (→ page 9).



Select the day in the graphical calendar and press **OK** or . (Days on which appointments have already been saved are highlighted in black.)

The list of saved appointments for the day is displayed. If you have already saved 30 appointments, you must first delete an existing appointment.

#### <New Entry>

Select and press **OK**.

- ▶ Change multiple line input:

#### Appoint.:

Select **On** or **Off**.

#### Date:

Enter day/month/year in 8-digit format.

#### Time:

Enter hours/minutes in 4-digits format.

#### Notes:

Enter text (max. of 16 characters). The text appears as the appointment name in the list and will be displayed on the screen during the appointment reminder. If you do not enter any text, only the date and time of the appointment are displayed.

#### Save

Press the display key.



Press and **hold** (idle status).

The appointment is marked with  in the appointments list. The list of appointments is sorted by date.

An appointment reminder is signalled with the selected ringer tone (→ page 49). The appointment reminder sounds for 60 seconds. The entered text, date and time are displayed.

During a call, the appointment reminder is signalled by a short tone.

### Managing appointments

---

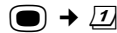

Select the day in the graphical calendar and press **OK** or . (Days on which appointments have already been saved are highlighted in black in the calendar.)



Select appointment for the day.

#### Options

Open menu.

Back with .

You have the following options:

#### View Entry

View selected appointment,

**Options** Open the menu for editing, deleting and activating / deactivating.

#### Edit Entry

Edit selected appointment.

#### Delete Entry

Delete selected appointment.

#### Activate / Deactivate

Activate / deactivate the selected appointment.

#### Delete List

Delete **all** appointments.

## Switching off or answering an appointment reminder

---

**Precondition:** An appointment reminder is sounding.

#### OFF

Press the display key to switch off the appointment reminder.

Or:

#### SMS

Press display key to answer the appointment reminder with a SMS.

## Displaying missed appointments and anniversaries

Missed appointments/anniversaries (→ page 22) are displayed in the **Missed Alarms** list if:

- ◆ You do not accept an appointment/anniversary.
- ◆ The appointment/anniversary was signalled during a phone call.
- ◆ The handset is deactivated at the time of the appointment/anniversary
- ◆ Automatic redial was activated at the time of an appointment/anniversary (→ page 23).

The most recent entry is at the head of the list.

If there is a new appointment/anniversary in the list, the display shows **Appoint.**. Pressing the display key will also open the **Missed Alarms** list.

To open the list from the menu:

 →  → **Missed Alarms**

Select appointment/anniversary.

Information about the appointment/anniversary is displayed. A missed appointment is displayed with the appointment name and a missed anniversary is displayed with the last name and first name. The date and time will also be given.

**Delete**

Delete appointment

**SMS**

Write a SMS.



Press and **hold** (idle status).

If 10 entries are already stored in the list, the next appointment reminder will delete the oldest entry.

## Using Bluetooth devices

Your Gigaset SL37H handset can communicate wirelessly via Bluetooth™ with other devices using this technology.

Before you can use your Bluetooth devices, you must first activate Bluetooth and then register the devices to the handset.

You can register 1 Bluetooth headset to the handset. You can also register up to 5 data devices (PC, PDA) to send and receive directory entries as vCards or exchange data with a computer (→ page 66).

In order to transfer phone numbers via Bluetooth connections, it is essential that area codes (international and local area codes) are stored on the phone (→ page 56).

You will find a description of how to operate your Bluetooth devices in the user guides for these devices.

### Please note:

- You can only operate headsets on your handset that have the **handset profile**.
- It can take up to 5 seconds to create a connection between your handset and a Bluetooth headset. This applies both when a call is accepted using the headset and one is transferred to the headset, and when a number is dialled from the headset.

## Activating/deactivating Bluetooth mode

 →  → **Data Transfer** → **Bluetooth** → **Activation**

Press **OK** to activate or deactivate Bluetooth mode ( = activated).

In idle status, the  icon on the handset shows that Bluetooth mode is activated:



**Please note:**

- If Bluetooth is activated and accessories (e.g. data cables page 66) are plugged into the connection socket (page 1), Bluetooth is automatically deactivated.
  - If a Bluetooth voice connection has already been established, Bluetooth is not deactivated until it is ended.
  - If a Bluetooth data connection has already been established, the response depends on the receiving device.
- Bluetooth is automatically reactivated when the accessories are removed.
- If Bluetooth is deactivated and accessories are plugged in, then Bluetooth cannot be activated.

**Registering Bluetooth devices**

The distance between the handset in Bluetooth mode and the activated Bluetooth device (headset or data device) should be no more than 10 m.

**Please note:**

- If you register a headset, any headset that is already registered will be overwritten.
- If you would like to use a headset with your handset that is already registered to another device (e.g. to a mobile phone), please **deactivate** this connection before you start the registration process to Gigaset.

 →  → **Data Transfer** → **Bluetooth** → **Search Headset / Search Data Device**

The search can take up to 30 seconds.

Once the device has been found, its name will be shown on the display.

**Options** Press the display key.

**Trust Device** Select and press **OK**.



Enter the PIN for the Bluetooth device you want to **register** and press **OK**.

The device is saved in the list of known devices.

**Cancelling/repeating current search**

To cancel search:

**Cancel** Press the display key.

Repeat search if necessary:

**Options** Select and press **OK**.



**Repeat Search**

Select and press **OK**.

**Editing the list of known (trusted) devices****Open list**

 →  → **Data Transfer** → **Bluetooth** → **Known Devices**

A corresponding icon appears next to each device name in the list displayed:

Icon	Meaning
	Bluetooth headset
	Bluetooth data device

**Viewing entries**

Open list →  (select entry)

**Options** Press the display key.

**View Entry** Select and press **OK**.  
Device name and address are displayed.  
Back with **OK**.

**De-registering a Bluetooth device**

Open list →  (select entry)

**Options** Press the display key.

**Delete Entry** Select and press **OK**.



Back: press and hold key.

**Please note:**

If you de-register an activated Bluetooth device, it may try to reconnect as an "unregistered device".

**Changing the name of a Bluetooth device**

Open list →  (select entry)

**Options** Press the display key.

**Rename** Select and press **OK**.



Change name



Press the display key



Back: Press and **hold** key.

### Rejecting/accepting an unregistered Bluetooth device

---

If a Bluetooth device that is not registered in the list of known devices tries to connect with the handset, you will be prompted on the display to enter the PIN for the Bluetooth device (bonding).

#### ◆ Reject

**Go Back** Press the display key.

#### ◆ Accept



Enter the PIN for the Bluetooth device you want to **accept** and press **OK**.

If you have accepted the device, you can use it temporarily (i.e. as long as it is within receiving range or until you deactivate the handset) or save it to the list of known devices.

Once the PIN has been confirmed, save to the list of known devices:

- Press the display key **Yes**.
- Press the display key **No**: use temporarily.

### Changing the Bluetooth name of the handset

---

You can change the handset name used to identify it on the display of another Bluetooth device.

 →  → **Data Transfer** → **Bluetooth** → **Own Device Name**

**Change** Press the display key



Change name

**Save** Press the display key



Back: Press and **hold** key.

### Setting your own area code

---

In order to transfer phone numbers between Bluetooth connections and phone, it is essential that your area code (international and local area code) is stored on the phone. Some of these numbers are already preset.

 →  → **Handset** → **Area Codes**

Check that the (pre)set area code is correct.

▶ Change multiple line input:



Select/change input field.



Navigate in the input field.



If necessary, delete number: press the display key.



Enter number.





Press the display key.

**Example:**

**Area Codes**

**International code:**  
00 - 49

**Local area code:** -  
00 - [89]

### Restoring the handset to factory settings

---

You can reset any individual settings and changes that you have made. Entries in the directory, the call-by-call list, the call history, the SMS lists and the handset's registration to the base station as well as the content of My stuff are retained.

 →  → **Handset** → **Reset Handset**

**Yes** Press the display key.



Press and **hold** (idle status).



## Base station settings

The base station settings are carried out using a registered Gigaset SL37H handset.

### Protecting against unauthorised access

Protect the system settings of the base station with a PIN known only to yourself. The system PIN must be entered when, for example, registering/de-registering a handset to/from the base station or when restoring the default settings.

### Changing the system PIN

You can change the 4-digit system PIN set on the base station (default setting: 0000) to a 4-digit PIN known only to yourself.

Gigaset SL375: Setting a system PIN facilitates remote operation of the answer machine (page 39).

#### → → Base → System PIN



Enter the current system PIN and press **OK**.



Enter new system PIN. For security the PIN is shown as four stars (\*\*\*\*).



Jump to the next line, re-enter new system PIN and press **OK**.



Press and **hold** (idle status).

### Resetting the system PIN

If you have forgotten your system PIN you can reset the base station to the original code **0000**:

Disconnect the power cord from the base station. Hold down the registration/paging key  on the base station while reconnecting the power cable to the base station. Release the key after a time.

The base has now been reset and the system PIN **0000** set.

## Activating/deactivating music on hold

#### → → Base → Music on hold

Press **OK** to activate or deactivate music on hold (= on).

## Repeater support

With a repeater you can increase the range and reception strength of your base station. You will need to activate repeater mode. This will terminate any calls that are in progress at the time.

**Precondition:** A repeater is registered. Eco mode is disabled.

#### → → Base → Add. Features → Repeater Mode

**Yes** Press the display key.

When repeater mode is active, the menu item is marked with .

#### **Please note:**

Repeater support and eco mode ( → page 12) cancel each other out, i.e. both functions cannot be used at the same time.

## Restoring the base station to the factory settings

When the settings are restored

- ◆ eco mode is disabled,
- ◆ handsets are still registered,
- ◆ the system PIN is not reset,
- ◆ the SMS information services are not reset.

#### → → Base → Base Reset



Enter the system PIN and press **OK**.

**Yes** Press the display key.

Cancel the restoring process by pressing  or the display key **No**.



Press and **hold** (idle status).

## Connecting the base station to the PABX

---

The following settings are only necessary when your PABX requires them; see the PABX user guide.

You cannot send or receive SMS messages on PABXs that do not support Calling Line Identification.

## Dialling modes and recall

---



The current setting is indicated by .

### Changing the dialling mode

---

The following dialling modes can be selected:

- ◆ Tone dialling (DTMF)
- ◆ Pulse dialling (DP)



 →  → Base → Add. Features → Dialling Mode



 Select dialling mode ( = on) and press **OK**.

 Press and **hold** (idle status).

### Setting recall

---

 →  → Base → Add. Features → Recall



 Select recall ( = on) and press **OK**.

 Press and **hold** (idle status).

## Saving an access code (outside line code)

---

**Precondition:** You may have to enter an access code for external calls in your PABX, e.g. "0".

 →  → Base → Add. Features → Access Code

 Enter or change access code, max. 3 digits.

▶ Save changes: (→ page 64).

If an access code has been saved,

- ◆ The access code is prefixed automatically when you select from the following lists: numbers of the SMS centres, call history or answer machine list.
- ◆ The access code must be entered when dialling manually and when manually entering directory, emergency/ quick dial numbers and SMS centre numbers.
- ◆ If you copy recipient's number from the directory when sending a SMS, you have to delete the access code.
- ◆ You delete an existing access code with **<C>**.

## Setting pauses

### Changing pause after line seizure

You can change the length of pause that is inserted between pressing the talk key  and sending the number.



Open menu.



Press keys.



Enter digit for the pause length (1 = 1 sec.; 2 = 3 sec.; 3 = 7 sec.) and press **OK**.

### Changing the pause after the recall key

You can change the length of the pause if your PABX requires this (refer to the user guide for your PABX).



Open menu.



Press keys.



Enter a digit for the length of the pause (1 = 800 ms; 2 = 1600 ms; 3 = 3200 ms) and press **OK**.

### Changing a dialling pause (pause after access code)

**Precondition:** You have saved an access code (→ page 58).



Open menu.



Press keys.



Enter a digit for the length of the pause (1 = 1 sec.; 2 = 2 sec.; 3 = 3 sec.; 4 = 6 sec.) and press **OK**.

To insert a dialling pause: press  for 2 seconds. A P appears in the display.

## Switching temporarily to tone dialling (DTMF)

If your PABX still operates with pulse dialling (DP), but you need touch tone dialling (DTMF) for a connection (e.g. to listen to the network mailbox) you must switch to touch tone dialling for the call.

**Precondition:** You are conducting a call or have already dialled an external number.



Press the star key.

After the call is ended, pulse dialling is automatically switched on again.

# Appendix

## Care

- ▶ Wipe the base station, charging cradle and the handset with a **damp** cloth (do not use solvent) or an antistatic cloth.

**Never** use a dry cloth. This can cause a build up of static.

## Contact with liquid

If the handset has come into contact with liquid:

1. **Switch off the handset and remove the battery pack immediately.**
2. Allow the liquid to drain from the handset.
3. Pat all parts dry, then place the handset with the battery compartment open and the keypad facing down in a dry, warm place **for at least 72 hours** (not in a microwave, oven etc.).
4. **Do not switch on the handset again until it is completely dry.**

When it has fully dried out, you will normally be able to use it again.

## Questions and answers

If you have any questions about using your phone, visit us at [www.gigaset.com/customer-care](http://www.gigaset.com/customer-care) at any time. The table below contains a list of common problems and possible solutions.

### Registration or connection problems with a Bluetooth headset.

- ▶ Reset the Bluetooth headset (see the user guide for your headset).
- ▶ Delete registration data from the handset when de-registering the device ( → page 55).
- ▶ Repeat the registration process ( → page 55).

### The display is blank.

1. The handset is not switched on.
  - ▶ Press **and hold** the end call key .
2. The battery pack is flat.
  - ▶ Charge/replace the battery pack ( → page 7).

### The keys of a handset do not respond when pressed.

The keypad lock is activated.

- ▶ Press and **hold** the hash key  ( → page 10).

### "Base station x" flashes on the display.

1. The handset is outside the range of the base station.
  - ▶ Move the handset closer to the base station.
2. The base station's range is reduced because eco mode is activated.
  - ▶ Deactivate eco mode ( → page 12) or reduce the distance between the handset and the base station.
3. The handset has been de-registered.
  - ▶ Register the handset ( → page 42).
4. The base station is not switched on.
  - ▶ Check the base station's mains adapter ( → page 7).

### Base Search flashes in the display.

The handset is set to **Best Base** and no base station is switched on or within range.

- ▶ Move the handset closer to the base station.
- ▶ Check the base station's mains adapter ( → page 7).

### Handset does not ring.

The ringer tone is switched off.

- ▶ Activate the ringer tone ( → page 50).

### You cannot hear a ringer/dialling tone from the fixed network.

The phone cord supplied has not been used or has been replaced by a new cord with the wrong jack connections.

- ▶ Please always use the phone cord supplied or ensure that the jack connections are correct when purchasing from a retailer ( → page 7).

### Error tone sounds after system PIN prompt.

You have entered the wrong system PIN.

- ▶ Reset the system PIN to 0000 ( → page 57).

<p><b>Forgetting the system PIN.</b></p> <p>▶ Reset the system PIN to 0000 ( → page 57).</p>
<p><b>Call charges are not displayed.</b></p> <p>1. Your network provider does not support this feature.</p> <p>2. There are no metering pulses.</p> <p>▶ Ask your network provider to transmit the metering pulses.</p>
<p><b>The other party cannot hear you.</b></p> <p>You have pressed the  (INT) key. The handset is "muted".</p> <p>▶ Switch on the microphone again ( → page 17).</p>
<p><b>The number of the caller is not displayed despite CLIP.</b></p> <p>Calling Line Identification is not enabled.</p> <p>▶ <b>The caller</b> should ask the network provider to release Calling Line Identification (CLI).</p>
<p><b>You hear an error tone when keying an input</b> (a descending tone sequence).</p> <p>Action has failed/invalid input.</p> <p>▶ Repeat the operation.</p> <p>Watch the display and refer to the user guide if necessary.</p>
<p><b>You cannot listen to messages on the network mailbox.</b></p> <p>Your phone system is set for pulse dialling.</p> <p>▶ Set your phone system to tone dialling.</p>

### Gigaset SL375 only:

<p><b>No time is specified for a message in the call history.</b></p> <p>Date/time is not set.</p> <p>▶ Set the date/time ( → page 9).</p>
<p><b>The answer machine reports 'PIN is incorrect' to the remote control.</b></p> <p>1. You have entered the wrong PIN</p> <p>▶ Enter the system PIN again</p> <p>2. The system PIN is still set to 0000.</p> <p>▶ Change the system PIN ( → page 57).</p>
<p><b>The answer machine is not recording any messages/has switched over to announcement.</b></p> <p>Its memory is full.</p> <p>▶ Delete old messages.</p> <p>▶ Play back new messages and delete.</p>

## Customer service & product warranty – Australia and New Zealand

---

### IMPORTANT

Please retain your sales receipt as proof of the date of purchase.

### Customer Service

If you require assistance in operating this product please contact us

AUS: 1300 780 878 or by e-mail at the Customer Care section of our website at

[www.gigaset.com/au](http://www.gigaset.com/au)

NZ: 0800 780 878 or by e-mail at the Customer Care section of our website at

[www.gigaset.com/au](http://www.gigaset.com/au)

If you are trying to access a Network Service and require assistance specifically related to the network service or would like to subscribe to the service, contact your service provider.

### Product Warranty

Subject to the conditions below, this product, excluding battery and accessory devices, is guaranteed against any defect in materials or workmanship under conditions of normal use for a period of 24 months from date of purchase.

The benefits conferred by this warranty are in addition to other warranties and remedies that are implied under the Australian Trade Practices Act and similar Country, State and Territory laws (Statutory Rights).

Subject to your Statutory Rights, the goods will not be eligible for service under this warranty if:

1. Proof of purchase cannot be provided;
2. The defect was caused by an accident, misuse, abuse, improper installation or operation, vermin infestation, lack of reasonable care, unauthorised modification, loss of parts, tampering or attempted repair by a person not authorised by Gigaset; or
3. The product has been damaged by lightning or a mains power surge.
4. The Phone was not imported into Australia by Gigaset Communications GmbH.

To obtain service during the terms of this warranty call the Information Line on

AUS: 1300 780 878 or by e-mail at the Customer Care section of our website at [www.gigaset.com/au](http://www.gigaset.com/au)

NZ: 0800 780 878

If it is necessary to have the product serviced, the Customer Service Representative will inform you of the product return process.

Please ensure that:

1. You provide proof of purchase;
2. Your product is suitably packaged; and
3. You have included all components from the original purchase.

Subject to your Statutory Rights:

1. Any claim under this warranty is limited to the cost of repair or replacement of the product; and
2. If the goods are found to be in sound working order by the authorised service centre, you may be charged a fee for service and for any other direct costs associated with having the product delivered for service.

Replacement or repair services are only offered for products purchased in Australia and New Zealand that bear Gigaset Communications GmbH local registered N Number and Telepermit markings.



Please have your proof of purchase ready when calling.

### Bluetooth Qualified Design Identity

The Bluetooth QD ID for your Gigaset SL37H is: B011264.

### Accessories

---

You can purchase accessories for your Gigaset, simply contact our Service Centre at [gigaset.com.au/servicecentre](http://gigaset.com.au/servicecentre).

## Specifications

### Recommended battery pack

(Valid at the time of going to press)  
 Technology: Lithium ion (Li-Ion):  
 Voltage: 3.7 V  
 Capacity: 700 mAh  
 Type: V30145-K1310-X250  
 V30145-K1310-X322

The handset is supplied with the recommended battery pack. Only the original battery pack may be used.

### Handset operating times/charging times

The operating time of your Gigaset depends on the capacity and the age of the batteries and the way they are used. (All times are maximum possible times and apply when the display backlight is deactivated.)

Standby time	approx. 350 hours (15 days)
Talktime	approx. 14 hours
Charging time	approx. 3.5 hours

### Base station power consumption

In standby mode:

Gigaset SL370: approx. 2 watt  
 Gigaset SL375: approx. 3 watt

During the call:

Gigaset SL370: approx. 2 watt  
 Gigaset SL375: approx. 3 watt

## General specifications

DECT standard	is supported
GAP standard	is supported
No. of channels	60 duplex channels
Radio frequency range	1880–1900 MHz
Duplex method	Time multiplex, 10 ms frame length
Channel grid	1728 kHz
Bit rate	1152 kbit/s
Modulation	GFSK
Language code	32 kbit/s
Transmission power	10 mW, average power per channel
Range	up to 300 m outdoors, up to 50 m indoors
Base station power supply	240V
Environmental conditions in operation	+5°C to +45°C; 20% to 75% humidity
Dialling mode	DTMF (touch tone dialling)/ DP (dial pulsing)



## Notes on the user guide

This section explains the meaning of certain typographical conventions that are used in this user guide.



### Example of a menu input

The steps you need to perform are shown in abbreviated form in the user guide. This is illustrated below using the example of "Setting the contrast for the display". The things you have to do are explained in the boxes.



### → → Display



- ▶ When the handset is in idle status, press the control key **in the centre** () to open the main menu.
- ▶ With the () control key, select the **Settings** line.
- ▶ Press () or press the display key **OK** to confirm the **Settings** function.

The **Settings** submenu is displayed.

- ▶ Press on the bottom of control key () until the **Display** menu function is selected.
- ▶ Press () or press the display key **OK** to confirm the selection.

**Contrast** Select and press **OK**.

- ▶ Press on the bottom of control key () until the **Contrast** menu function is selected.
- ▶ Press () or press the display key **OK** to confirm the selection.

 Select contrast and press () or press the display key **Save**.

- ▶ Press on the right or left of the control key to set the contrast.
- ▶ Press () or press the display key **Save** to confirm the selection.

 Press and **hold** (idle status).

- ▶ Press and hold the end call key until the handset returns to idle status.

## Example of multiple line input

In many situations you can change settings or enter data in several lines of a display.

In this user guide icons are used to guide you step by step through multiple line input. This is illustrated below using the example of

"Setting the date and time". The things you have to do are explained in the boxes.

You will see the following display (example)



### **Date:**

Enter the day, month and year in 8-digit format.

The second line is marked with [ ] to show it is active.

- ▶ Enter the date using the digit keys.

### **Time:**

Enter hours/minutes in 4-digits format.

- ▶ Press the () key.

The fourth line is marked with [ ] to show it is active.

- ▶ Enter the date using the digit keys.





- ▶ Save the changes.

- ▶ Pressing the display key **Save**.
- ▶ Then press and **hold** the  key.

The handset switches to idle status.

## Writing and editing text

The following rules apply when writing a text:

- ◆ Control the cursor with    .
- ◆ Characters are inserted on the left of the cursor.
- ◆ Press the star key  to show the table of special characters.















- ◆ The first letter of the name of directory entries is automatically capitalised, followed by lower case letters.

You can call up the table of special characters when writing a SMS using the  key. Select the required character and insert it with **Insert**.

## Writing a SMS/name (without predictive text)

Press the relevant key several times to enter letters/characters.



### Standard characters

	1x	2x	3x	4x	5x	6x	7x	8x	9x	10x
				1						
	a	b	c	2	ä	á	à	â	ã	ç
	d	e	f	3	ë	é	è	ê		
	g	h	i	4	ï	í	ì	î		
	j	k	l	5						
	m	n	o	6	ö	ñ	ó	ò	ô	õ
	p	q	r	s	7	ß				
	t	u	v	8	ü	ú	ù	û		
	w	x	y	z	9	ÿ	ý	æ	ø	å
	.	,	?	!	0					

- 1) Space
- 2) Line break

When you press and **hold** a key, the characters of that key appear in the display and are highlighted one after the other. When you release the key, the highlighted character is inserted into the input field.



### Setting upper/lower case or digits

Press the hash key  **briefly** to switch from "Abc" mode to "123" and from "123" to "abc" and from "abc" to "Abc" (upper case: 1st letter upper case, all others lower case). Press the hash key  **before** entering the letter.

You can see in the display whether upper case, lower case or digits is selected.

## Writing SMS (with predictive text)

EATONI predictive text helps you when you are writing SMS messages.

Each key between  and  is assigned several letters and characters. These appear in a selection line immediately under the text panel (over the display keys) as soon as you press a key. The letter you are most likely looking for is shown in reversed highlights and is at the beginning of the selection line. It is copied into the text panel.

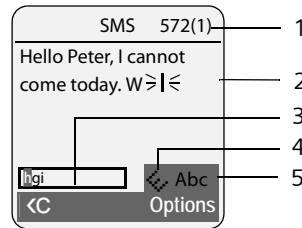

- 1 Remaining number of characters, in brackets: SMS part 1-n
- 2 SMS text
- 3 Selection line
- 4 EATONI is activated
- 5 Upper/lower case or digits

If this letter is the one you want, confirm it by pressing the next key. If it does not match the one you want, press the hash key  **briefly** until the letter you are looking for is reverse highlighted in the display line and then transferred to the text field.

If you press and **hold** the hash key  you switch from "Abc" mode to "123" and from "123" to "abc" and from "abc" to "Abc".

### Activating/deactivating predictive text

**Precondition:** you are writing a SMS message.

**Options**  Press the display key.

### Predictive Text

Select and press **OK** ( = on).



Press the end call key **briefly** to return to the text field. Enter the text.

## Additional functions via the PC interface

---

You can connect the handset to your computer via Bluetooth ( → page 54) or by using a data cable ( → page 74). If you want to use the Bluetooth connection, your computer must be equipped with a suitable dongle.

Your handset can communicate with the computer using the "Gigaset QuickSync" program (free download at [www.gigaset.com/gigasetSL370](http://www.gigaset.com/gigasetSL370)).

You can

- ◆ access your handset's directory and synchronise it with Outlook, or copy contact details to the handset,
- ◆ download CLIP pictures (.bmp) from the computer to the handset,
- ◆ download pictures (.bmp) for the screen-saver from the computer to the handset.

During the transfer of data between handset and PC, you will see  on the display. During this time the keypad is disabled, and incoming calls will be ignored.

### Please note:

- If Bluetooth is activated and accessories (e.g data cables page 66) are plugged into the connection socket (page 1), Bluetooth is automatically deactivated.
- If a Bluetooth voice connection has already been established, Bluetooth is not deactivated until it is ended.
- If a Bluetooth data connection has already been established, the response depends on the receiving device.
- Bluetooth is automatically reactivated when the accessories are removed.
- If Bluetooth is deactivated and accessories are plugged in, then Bluetooth cannot be activated.

## Wall-mounting the base station

---

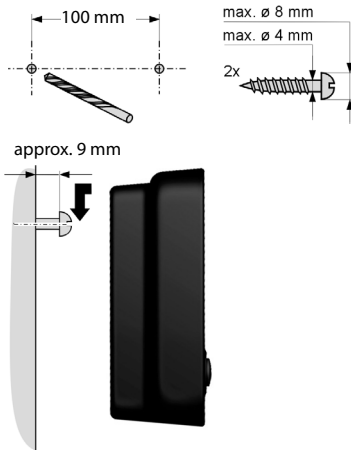

### Data Cable USB DCA-510

For connecting your phone to the USB interface of your computer.

# Index

---

## A

- Accepting calls
  - accepting a call . . . . . 16
- Access code
  - for a PABX . . . . . 58
- Access protection . . . . . 57
- Accessories . . . . . 62
- Activating
  - advisory tones . . . . . 52
  - answer machine . . . . . 35
  - answer machine (remote operation) . . . . . 40
  - appointment . . . . . 53
  - Bluetooth mode . . . . . 54
  - call acceptance . . . . . 49
  - handset . . . . . 10
  - internal listening in . . . . . 44
  - keypad lock . . . . . 10
  - room monitor . . . . . 45, 46
  - two-way recording . . . . . 38
- Advisory tones . . . . . 52
- Alarm clock . . . . . 52
- Alert tone . . . . . 50
- Anniversary . . . . . 22
  - deactivating . . . . . 22
  - missed . . . . . 22, 54
  - saving in directory . . . . . 22
- Announcement (answer machine) . . . . . 35, 36
- Announcement mode (answer machine) . . . . . 35, 36
- Answer machine . . . . . 35
  - activating/deactivating . . . . . 35
  - deleting messages . . . . . 37
  - list . . . . . 23, 24
  - playing back messages . . . . . 36
  - recording a personal announcement/announce only . . . . . 35
  - remote operation . . . . . 39
  - scrolling back . . . . . 37
  - scrolling forward . . . . . 37
- Answer machine, see also Network mailbox
- Appointment . . . . . 53
- Appointment/anniversary display missed . . . . . 54

- Appointments
  - activating/deactivating . . . . . 53
  - deleting . . . . . 53
  - managing . . . . . 53
- Area code
  - setting own dialling code . . . . . 56
- Assigning a key . . . . . 47
- Assigning numerical keys . . . . . 47
- Automatic
  - call acceptance . . . . . 16, 49
  - last number redial . . . . . 23
  - network provider preselection . . . . . 25

## B

- Base station
  - changing . . . . . 42
  - connecting . . . . . 7
  - connecting and installing . . . . . 6
  - connecting to PABX . . . . . 58
  - range . . . . . 7
  - restoring factory settings . . . . . 57
  - setting . . . . . 57
  - system PIN . . . . . 57
- Battery pack
  - charging . . . . . 1, 9
  - display . . . . . 1, 9
  - icon . . . . . 1, 9
  - inserting . . . . . 7
  - recommended battery pack . . . . . 63
  - tone . . . . . 52
- Beep, see Advisory tones
- Best base station . . . . . 42
- Birthday, see Anniversary

## Bluetooth

- answering a call . . . . . 16
- changing device name . . . . . 55, 56
- de-registering devices . . . . . 55
- list of known devices . . . . . 55
- registering devices . . . . . 55
- transferring directory (vCard) . . . . . 21
- Bluetooth connection
  - setting own area code . . . . . 56

## C

- Calendar . . . . . 53
- Call
  - acceptance . . . . . 39, 49
  - accepting . . . . . 16
  - answering (Bluetooth) . . . . . 16
  - duration . . . . . 16

## Index

ending	16
external	16
history	24
internal	43
party listening in	44
picking up from answer machine	38
screening during recording	38
transferring (connect)	43, 44
two-way recording	38
Call waiting	
internal call	43
Call-by-call	19
numbers	19, 25
Call-by-call list	
key	1
Calling	
external	16
Calling Line Identification	16
Care of the telephone	60
Changing	
destination number	46
device name (Bluetooth)	55, 56
dialling mode	58
display language	48
earpiece volume	49
handsfree volume	49
internal number of a handset	44
name of a handset	44
pause time	59
ringer tone	49
system PIN	57
Character set	28, 30
Charge saving function (remote operation)	39
Charge status display	1, 9
CLI, CLIP	16
CLIP picture	17, 19, 51
CNIP	16
Conference call (internal)	43
Configuring the network mailbox	41
Confirmation tone	52
Connecting, base station to PABX	58
Consultation call (internal)	43
Control key	1, 10
Correcting incorrect entries	12
Customer service & product warranty	
– Australia and New Zealand	61

## D

Deactivating	
advisory tones	52
answer machine	35
appointment	53
appointment reminder	53
call acceptance	49
handset	10
internal listening in	44
keypad lock	10
preselection	26
room monitor	46
two-way recording	38
Delete key	10
Deleting	
announcement for answer machine	36
characters	12
message	37
De-registering (handset)	42
De-registering devices (Bluetooth)	55
Destination number	
(room monitor)	45, 46
Dialling	
call-by-call list	20
directory	20
mode	58
quick dial	47
with quick dial	21
Dialling pause	59
entering	1
Directory	19
copying number from text	21
managing entries	20
opening	10
order of entries	20
save anniversary	22
saving entry	19
sending entry/list to handset	21
storing the sender's number (SMS)	30
transferring a vCard (Bluetooth)	21
using to enter numbers	22
Display	
backlight	49
changing display language	48
contrast	48
in idle status	11
memory (directory/call-by-call)	21

- memory (My stuff) . . . . . 51
- missed appointments/
  - anniversaries . . . . . 54
- name (CNIP) . . . . . 16
- network mailbox report . . . . . 41
- number (CLI/CLIP) . . . . . 16
- screensaver . . . . . 48
- setting . . . . . 48
- wrong language . . . . . 48
- Display keys . . . . . 1, 10
  - assigning . . . . . 47
- DP (pulse dialling) . . . . . 58
- Draft message list (SMS) . . . . . 28
- E**
- Earpiece mode . . . . . 17
- Earpiece volume . . . . . 49
- EATONI (predictive text) . . . . . 65
- ECO DECT. . . . . 12
- Eco mode . . . . . 12
- E-mail address . . . . . 29
- Email address
  - copying from the directory . . . . . 22
- End call key . . . . . 1, 16
- Ending, call. . . . . 16
- Ending, see deactivate
- Entry
  - saving, changing (preselection) . . . . . 26
  - selecting (menu) . . . . . 64
  - selecting from directory . . . . . 20
- Error tone. . . . . 52
- Example
  - menu input . . . . . 63
  - multiple line input . . . . . 64
- External call
  - forwarding to answer machine . . . . . 38
- F**
- Fast access
  - answer machine . . . . . 39
  - network mailbox . . . . . 41
- Fax (SMS) . . . . . 29
- Flash time . . . . . 58
- G**
- Group call . . . . . 43
- H**
- Handset
  - activating/deactivating. . . . . 10
  - advisory tones . . . . . 52
  - changing internal number . . . . . 44
  - changing name. . . . . 44
  - changing the number . . . . . 44
  - changing to a different base
    - station . . . . . 42
  - changing to best reception . . . . . 42
  - contact with liquid . . . . . 60
  - de-registering. . . . . 42
  - display backlight. . . . . 49
  - display language. . . . . 48
  - earpiece volume . . . . . 49
  - handsfree volume . . . . . 49
  - idle status . . . . . 11
  - list. . . . . 10
  - locating . . . . . 42
  - muting . . . . . 17
  - paging. . . . . 42
  - registering . . . . . 42
  - registering to a different base
    - station . . . . . 42
  - restoring to factory settings . . . . . 56
  - screensaver . . . . . 48
  - setting . . . . . 47
  - setting up . . . . . 7
  - signal strength . . . . . 7
  - transferring a call . . . . . 43
  - using room monitor . . . . . 45
  - using several . . . . . 42
- Handset operating time
  - in room monitor mode . . . . . 45
- Handsfree key . . . . . 1
- Handsfree talking. . . . . 17
- Handsfree volume . . . . . 49
- Hash key . . . . . 1, 10
- Hearing aids . . . . . 4
- Hold music . . . . . 17, 57
  - setting . . . . . 57
- I**
- Icon
  - alarm clock. . . . . 52
  - answer machine . . . . . 35
  - battery pack . . . . . 9
  - display. . . . . 10
  - for new messages . . . . . 23
  - keypad lock . . . . . 10
  - new message . . . . . 37
  - new SMS . . . . . 29
  - ringer tone . . . . . 50
  - Idle status (display). . . . . 11

## Index

- Idle status, returning to . . . . . 11
- Incoming message list (SMS). . . . . 29
- Incorrect input (correction). . . . . 12
- Information services (SMS) . . . . . 32
- Input language (SMS) . . . . . 28
- Installation, base station. . . . . 6
- Internal
  - conference . . . . . 43
  - consulting. . . . . 43
  - listening in . . . . . 44
  - making calls . . . . . 43
- Internal call . . . . . 43
  - call waiting . . . . . 43
- K**
- Key 1 (fast access) . . . . . 1, 39
- Keypad lock . . . . . 10
- Keys
  - call-by-call list . . . . . 1
  - control key . . . . . 1, 10
  - delete key . . . . . 10
  - display keys. . . . . 1, 10
  - end call key . . . . . 1, 16
  - fast access. . . . . 1, 39
  - handsfree key . . . . . 1
  - hash key . . . . . 1, 10
  - message key . . . . . 1
  - on/off key . . . . . 1
  - quick dial . . . . . 21
  - recall key . . . . . 1
  - star key. . . . . 1
  - talk key. . . . . 1, 16
- L**
- Language, display . . . . . 48
- Last number redial . . . . . 22
- Linking, see SMS
- Liquid . . . . . 60
- List . . . . . 19
  - answer machine . . . . . 23, 24
  - call history . . . . . 24
  - call-by-call list . . . . . 19
  - handsets. . . . . 10
  - known devices (Bluetooth) . . . . . 55
  - missed calls . . . . . 24
  - network mailbox . . . . . 24
  - SMS draft message list . . . . . 28
  - SMS incoming message list . . . . . 29
  - SMS list . . . . . 24
- Listening in to call . . . . . 44
- Locating, handset. . . . . 42
- Lock
  - activating/deactivating keypad protection . . . . . 10
- M**
- Mailbox ID, see SMS
- Mailboxes, see SMS
- Mains adapter . . . . . 4
- Making calls
  - accepting a call. . . . . 16
  - external . . . . . 16
  - internal . . . . . 43
- Making cost-effective calls. . . . . 25
- Manual last number redial. . . . . 22
- Medical appliances. . . . . 4
- Memory
  - directory/call-by-call . . . . . 21
  - My stuff . . . . . 51
- Menu
  - end tone . . . . . 52
  - menu guidance . . . . . 11
  - menu input . . . . . 63
  - opening. . . . . 10
  - overview . . . . . 13
- Message key
  - open list. . . . . 29
  - opening lists. . . . . 23
- Messages . . . . . 35
  - deleting. . . . . 37
  - key . . . . . 1
  - marking as "new" . . . . . 37
  - new message icon. . . . . 37
  - playing back. . . . . 36
- Microphone. . . . . 1
- Missed
  - anniversary . . . . . 54
  - appointment . . . . . 54
  - calls. . . . . 24
- Multiple line input . . . . . 64
- Muting the handset . . . . . 17
- My stuff. . . . . 51

- N**
- Name
    - displaying caller's name (CNIP) . . . . . 16
    - of a handset . . . . . 44
  - Network provider (numbers list) . . . . . 19
  - Network provider preselection,
    - automatic . . . . . 25
  - Network services . . . . . 18
  - Notification by SMS . . . . . 30
  - Number
    - as destination for room
      - monitor . . . . . 45, 46
    - copying from a SMS text . . . . . 30
    - copying from directory . . . . . 22
    - copying to directory . . . . . 21
    - displaying caller's number (CLIP) . . . . 16
    - entering with directory . . . . . 22
    - saving in the directory . . . . . 19
  - Numbers list
    - network provider . . . . . 19
- O**
- On/Off key . . . . . 1
  - Order in directory . . . . . 20
  - Outside line code . . . . . 58
- P**
- PABX
    - connecting base station . . . . . 58
    - pauses . . . . . 59
    - saving access code . . . . . 58
    - setting dialling mode . . . . . 58
    - setting recall . . . . . 58
    - SMS . . . . . 33
    - switch to touch tone dialling . . . . . 59
  - Pack contents . . . . . 6
  - Paging . . . . . 42
  - Paging key . . . . . 1
  - Pause . . . . . 59
  - PC interface . . . . . 66
  - Phone jack assignment . . . . . 7
  - Picture
    - deleting . . . . . 51
    - renaming . . . . . 51
  - PIN change
    - system PIN . . . . . 57
  - Playing back
    - announcement (answer machine) . . . . 35
    - message (answer machine) . . . . . 36
  - Power consumption . . . . . 63
  - Predictive text . . . . . 65
  - Preselection . . . . . 25
    - deactivating . . . . . 26
  - Protecting the phone against access . . . 57
  - Pulse dialling . . . . . 58
- Q**
- Questions and answers . . . . . 60
  - Quick dial . . . . . 19, 47
- R**
- Range . . . . . 7
  - Recall . . . . . 58
  - Recall key . . . . . 1
    - pause after . . . . . 59
  - Reception booster, see Repeater
  - Recording
    - two-way recording . . . . . 38
  - Recording quality . . . . . 39
  - Recording time . . . . . 39
  - Registering (handset) . . . . . 42
  - Registering devices (Bluetooth) . . . . . 55
  - Registration key . . . . . 1
  - Reminder call . . . . . 22
  - Remote operation . . . . . 39
  - Repeater . . . . . 57
  - Ringer tone
    - changing . . . . . 49
    - setting volume . . . . . 49
  - Room monitor . . . . . 45
- S**
- Saving (access code) . . . . . 58
  - Screensaver . . . . . 48
  - Searching in directory . . . . . 20
  - Sending
    - directory entry to handset . . . . . 21
  - Sensitivity (room monitor) . . . . . 45, 46
  - Setting
    - date . . . . . 9
    - screensaver . . . . . 48
    - time . . . . . 9
  - Setting up
    - handset . . . . . 7
  - Shortcut . . . . . 13
  - Signal strength . . . . . 7
  - Silent alert . . . . . 50
  - SIM card
    - setting own area code . . . . . 56

## Index

SMS . . . . .	27
active send service centre . . . . .	27
changing mailbox . . . . .	31
deleting . . . . .	28
draft message list . . . . .	28
forwarding . . . . .	30
incoming message list . . . . .	29
information services . . . . .	32
input language . . . . .	28
linked . . . . .	27
list . . . . .	24
mailbox ID . . . . .	31
mailboxes . . . . .	31
notification by SMS . . . . .	30
notification number . . . . .	30
notification type . . . . .	31
PIN protection . . . . .	31
reading . . . . .	28
receiving . . . . .	29
registration wizard . . . . .	27
replying to and forwarding . . . . .	30
rules . . . . .	27
saving number . . . . .	30
self help with error messages . . . . .	34
sending as a fax . . . . .	29
sending to a personal mailbox . . . . .	32
sending to an e-mail address . . . . .	29
to a PABX . . . . .	33
troubleshooting . . . . .	34
writing . . . . .	27
SMS centre . . . . .	
changing number . . . . .	32
setting . . . . .	32
Snooze mode . . . . .	52
Sound, see Ringer tone . . . . .	
Special functions . . . . .	58
Specifications . . . . .	63
Star key . . . . .	1
System settings . . . . .	57

## T

Talk key . . . . .	1, 16
Text message, see SMS . . . . .	
Touch tone dialling . . . . .	58, 59
Troubleshooting . . . . .	60
Troubleshooting (SMS) . . . . .	34

## U

Unknown . . . . .	17
Unknown caller . . . . .	17

## V

Viewing the network mailbox report . . . . .	41
VIP (directory entry) . . . . .	20
Volume . . . . .	
earpiece . . . . .	49
earpiece volume . . . . .	49
handset handsfree volume . . . . .	49
loudspeaker . . . . .	49
ringer tone . . . . .	49
setting . . . . .	50

## W

Warning tone, see Advisory tones . . . . .	
Writing (SMS) . . . . .	27
Writing, editing text . . . . .	64