CALLER ID HANDSFREE HEADSET BUSINESS TELEPHONE



MODEL IQ335

OPERATING INSTRUCTIONS

INTERQUARTZ®

CONTENTS

1. FEATURES	1
“HEADSET SAVVY” FEATURES	1
CALLER ID (CLI) FEATURES	1
GENERAL FUNCTIONS	2
OPERATING REQUIREMENTS	3
LIQUID CRYSTAL DISPLAY	3
MESSAGE WAITING	3
2. SETTING UP	4
UNPACKING	4
GENERAL SETTING-UP	4
LINE CONNECTION	4
DISPLAY CONTRAST ADJUSTMENT	4
DATE AND TIME SET UP DISPLAY	4
BASIC OPERATION	6
3. GENERAL CONTROLS AND INDICATORS	7
RINGER/MESSAGE WAITING INDICATOR	8
RINGER VOLUME SWITCH	8
RINGER PITCH CONTROL	8
ALPHA-NUMERIC KEYPAD	8
RESET BUTTON	8
CRADLE SWITCH	9
VOLUME ▲ and VOLUME ▼ KEYS	9
RECALL KEY	9
REDIAL KEY	9
<i>To redial last number</i>	9
<i>To direct redial the last number</i>	9
PAUSE FUNCTION	10
<i>For manual dialing:</i>	10
MUTE KEY AND INDICATOR	10
HANDSFREE/HEADSET KEY AND INDICATOR	10
<i>To use Handsfree mode</i>	10
<i>To use Headset mode</i>	10
CURSOR ◀ AND ▶ KEYS	10
AUTOMATIC CALL TIMER	10
DATA PORT	10
BATTERY COMPARTMENT	11
DISPLAY ICONS AND FIELDS	11
4. HANDSFREE OPERATION	13
<i>Incoming calls using Handsfree:</i>	13
<i>Outgoing calls using Handsfree (manual or memory dialing):</i>	13
<i>Changing from Handsfree to Handset during a call:</i>	13
<i>Changing from Handset to Handsfree during a call:</i>	13

5. HEADSET OPERATION	14
BASIC OPERATION.....	14
HEADSET/HANDSET/HANDSFREE MODES	14
TRAINEE/SUPERVISOR MODE	14
<i>Silent Ringing</i>	14
ALERT LIGHT SUPPORT	15
6. MEMORY OPERATION	16
MEMORY STORAGE	16
<i>Memory Backup</i>	16
<i>Memory Storage</i>	16
DIRECT ACCESS MEMORY KEYS	16
<i>Direct Access Memory Capacity</i>	16
<i>Speed-Dialing (Storable Handsfree code)</i>	16
<i>Speed-Dialing and Automatic Hang-up</i>	17
<i>To view the contents of a Direct Access memory</i>	17
<i>To store a Number and Name in a Direct Access memory</i>	17
<i>To dial from a Direct Access memory</i>	17
<i>Direct Access Memories and the Memory Protect Switch</i>	18
<i>To program or alter the contents of a protected Direct Access memory:</i>	18
<i>To dial from a Protected Direct Access Memory</i>	19
DIRECTORY MEMORY	19
<i>Scrolling (▲ ▼) and Editing (◀ ▶) keys</i>	19
<i>Directory Memory Capacity</i>	19
<i>To Store a Number and Name into a Directory memory.....</i>	20
<i>To dial from the Directory memory using Name Search</i>	20
<i>To edit an entry in the Directory memory</i>	20
<i>To delete an entry from Directory memory</i>	20
LAST NUMBER REDIAL MEMORY	21
<i>Using the 5-Stack Last Number Redial Memory</i>	21
7. USING THE CALLER ID DISPLAY	22
CALL WAITING DISPLAY	23
<i>Calls list</i>	23
<i>Scrolling (▲ ▼) keys</i>	23
<i>To view the Calls List and dial a Number in the Calls List</i>	23
<i>To store a caller's details in a Direct Access memory from the Calls List</i>	25
<i>To store a caller's details in the Directory memory from the Calls List</i>	25
<i>To delete a Call from the Calls List or to delete the entire Calls List</i>	25
8. ADVANCED NETWORK OPERATION	26
<i>Message Waiting function in conjunction with Telstra's Customnet, Home Messages 101 services and MessageBank</i>	26
<i>Manually Resetting the Message Waiting Prompts</i>	26
<i>"Talking Text" SMS Messages</i>	26
HOLDING AND TRANSFERRING CALLS	26
PAUSE FUNCTION WHEN DIALING OUT	26
AUTOMATIC TRUNK ACCESS DIGIT INSERTION	26
<i>Automatic pause insertion</i>	27
PAUSE TIME	27
HOLDING AND TRANSFERRING CALLS	28
USING THE MEMORIES	28
<i>Speed Dialing</i>	28
<i>Cascade Memory Dialing</i>	28

9. INSTALLATION	29
GENERAL SETTING-UP	29
LINE CONNECTION	29
LOCATION	29
WALL MOUNTING	29
TECHNICAL ADJUSTMENTS - FOR CORRECT OPERATION	31
RECALL TIMING SELECTION	31
MESSAGE WAITING LIGHT COMPATIBILITY	31
HEADSET MIC ADJUST CONTROL	31
<i>To make a Headset mic level adjustment</i>	31
HEADSET POLARITY SWITCH	32
TABLE 1	33
10. GENERAL CARE AND MAINTENANCE	34
CLEANING	34
FAILURE TO OPERATE AND SERVICE DIFFICULTIES	34
11. THUNDERSTORMS	35
12. SERVICE	36
13. WARRANTY: 3 YEARS PARTS & LABOUR	36

1. FEATURES

“HEADSET SAVVY” FEATURES

- Auto detect circuitry disables handsfree when headset is in use
- Mute key for headset microphone
- Electronic earpiece volume control
- Built-in headset amplifier suits a wide range of headset types
- Headset mic adjustment allows any headset mic type
- Headset cable polarity switch suits any headset cord
- “Silent Ringing” mode selectable so that incoming calls ring only in the headset to reduce office noise
- Trainee/Supervisor “Double Jacking” mode
- Change between headset, handsfree and handset modes during a call
- Built-in acoustic shock protection
- Compatible with “Talking Text” SMS services

CALLER ID (CLI) FEATURES

- Compatible to Bellcore GR-30-CORE Caller ID standard
- Supports Type 2 Caller ID Call Waiting (CIDCW) during a call
- Supports Telstra’s Flashing Message Indicator for Home Messages 101 and MessageBank
- Large Liquid Crystal 3-line Display
- Receives and displays caller’s name and number
- Saves 80 callers’ names (16 characters) and numbers (32 digits)
- Date/Time stamp of each call in 24-hour format
- New call, Repeat call indication
- Answered/Unanswered indication of incoming calls in Calls list
- Delete a single call or all information from the Calls list, Directory and Redial memories
- Blinking calls LED indicates a new incoming call and/or Message Waiting
- On-screen Message Waiting indicator

GENERAL FUNCTIONS

- Alpha-numeric keypad
- Direct redial allows immediate redialing of the last number without hanging up
- Redial any of the last 5 dialed numbers
- 20 Direct Access memories, 10 one-touch and 10 two-touch accessible via 10 keys; capacity 32 number digits and 16 name characters
- 80 Calls list memories; capacity 32 number digits and 16 name characters
- 100 Directory memories; capacity 32 number digits and 16 name characters
- Date and Time display
- Automatic call duration timer
- User selectable Timed-break Recall: 100ms, 200ms, 300ms and 600ms. Factory set to 100ms
- User selectable Pause timings of 100ms and 1 second. Factory set to 1 second
- Manual and storable pause
- User selectable High/Low/Off ringer volume control
- User adjustable ringer pitch control
- Visual ringer indication with high voltage message waiting and BP250 message waiting built-in (see Caller ID section for details of Centrex message waiting)
- Mute key with LED visual indicator
- Handsfree/Headset key with LED indicator
- Switch between Handsfree, Headset and Handset modes mid-call
- Volume control (handset and headset earpieces and handsfree speaker)
- The Calls list, Directory and Direct Access memories are non-volatile (no batteries needed)
- EEPROM memory allows mass pre-programming of the upper row of 5 Direct Access memory keys (i.e. 10 memories) to create network feature access keys
- Desk or wall mountable
- On-screen warning icons to indicate "Low Battery" and "Adaptor Failure" power conditions
- Data port provides access for computers answering machines and cordless phones.

OPERATING REQUIREMENTS

- Any 2-wire analog line; if the IQ335's Caller ID feature is required, please ensure that your line delivers the necessary Caller ID data
- 240V mains outlet for 9V mains power adaptor (supplied) for full support of all functions
- If 3 x AA Alkaline batteries (not supplied) are fitted in the absence of mains adaptor or during mains power failure, they can provide up to one month's support of all functions
- If no adaptor or battery power available - basic telephone operation (will automatically power up approximately 1 second after lifting handset)
- Memory backup - no batteries required. All memories (except the Redial memory) are non-volatile; their contents will be retained without any power

LIQUID CRYSTAL DISPLAY

- Liquid Crystal Display with a row of useful icon indicators, a number field and a name field (16 characters each)

MESSAGE WAITING

The following types are supported:

- PABX compatible to 80VDC signal with red LED indicator - some systems require the fitting of optional circuitry
- Polarity reversal (e.g. Ericsson BP250) message waiting light built-in with red LED indicator
- Bellcore (e.g. Telstra Spectrum, Cisco and Nortel DMS) with both on-screen and LED indicators
- Type 2 Caller ID Call Waiting (CIDCW) during a call

2. SETTING UP

UNPACKING

The carton contains the following:

- Telephone body and handpiece
- Coiled handset cord and line cord
- 9V DC adaptor
- Quick Start Guide

GENERAL SETTING-UP

1. Fit the coiled cord to the appropriate sockets in the handset and in the telephone base - please do not connect the coiled cord into the headset jack
2. Fit the line cord to the rear socket and to your telephone network outlet
3. Set the Ringer Volume and the Ringer Pitch controls
4. Lift the handset to check for dial tone and to wake up the display
5. If using a headset, connect it to the headset jack (See Figure 2B)
6. Fit the adaptor plug to the 9V DC Jack and plug in the adaptor to a mains power outlet
7. Follow the instructions below for general installation
8. See section 9 for other installation instructions and technical settings.

LINE CONNECTION

This telephone is supplied with a line cord and plug compatible with 8 pin modular (RJ45) wall sockets, with the centre pair being used for all telephony functions. Some units may be supplied with an advanced type plug compatible with both 8 pin and 6 pin modular wall sockets as standard. Other types of plugs and cords are available on request.

DISPLAY CONTRAST ADJUSTMENT

Certain background lighting conditions may cause the display to show unlit characters. To set optimum display performance for your telephone, make sure that the telephone is on-hook and in an idle state. Press STORE followed by ▲ (“VOL+”) and ▼ (“VOL-”) keys to achieve the best contrast for your lighting conditions.

DATE AND TIME SET UP DISPLAY

The best time to set up the Date and Time is during installation, as follows:

Upon installation the display will automatically show step by step prompts to guide you through the Date and Time setup procedure. This procedure can also be used at any time to change the time and date settings. The following procedure assumes that all steps in the “General Setting Up” have been carried out.

If you subscribe to a Caller ID service, the clock may automatically be synchronised to the network’s clock when the telephone receives its first incoming call containing Caller ID data.



FIGURE 1A: DATE SETTING

1. If the display is blank, lift the Handset briefly to wake up the telephone. Replace the Handset in the cradle
2. For 10 seconds the display will show “20040101” and “DATE-YYYYMMDD” when the unit is first powered up
3. If the display is alive but not showing “20040101” and “DATE-YYYYMMDD”, press STORE and then # ; the display will return to the “20040101” and “DATE-YYYYMMDD” mode. Proceed to step 4 within the next 10 seconds; repeat step 3 if necessary to re-enter Date/Time setting mode.
4. Enter Year (4 digits), Month (2 digits) and Date (2 digits)

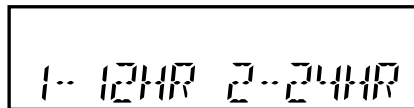

FIGURE 1B: HOUR MODE SETTING

5. Hour Mode Setting - the display will now show “12-HR 24-HR”
6. Press 1 for 12 hour mode or 2 for 24 hour mode display (if 24 hour mode was chosen, please go to step 9)

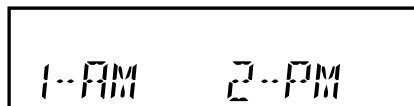

FIGURE 1C: AM/PM SETTING

7. If 12-hour mode was selected above, the display will show “1-AM 2-PM”
8. Press 1 or 2 to select AM or PM time display

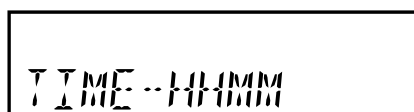

FIGURE 1D: TIME SETTING

9. The display will show “TIME-HHMM” after completion of the hour mode setting
10. To set the current time enter 2 digits for the hour, followed by two digits for the minutes
11. The display will show “CLOCK STORED” and the date and time will be updated.

*Note: use * key and # key to change any incorrect entries while carrying out the above procedure.*

BASIC OPERATION

The IQ335 can be used in the same way as a normal telephone; simply lift the handset to answer an incoming call, or lift the handset and dial on the keypad to commence an outgoing call. Please refer to other sections for more about Handsfree, Headset, Caller ID display and Memory operations. The telephone will also operate in a basic mode when mains power has failed and if batteries have not been fitted (the telephone will automatically power up approximately 1 second after lifting handset). If 3 x AA alkaline batteries (not supplied) are fitted in the absence of mains adaptor or during mains power failure, they can provide up to one month's support of all functions.

3. GENERAL CONTROLS AND INDICATORS

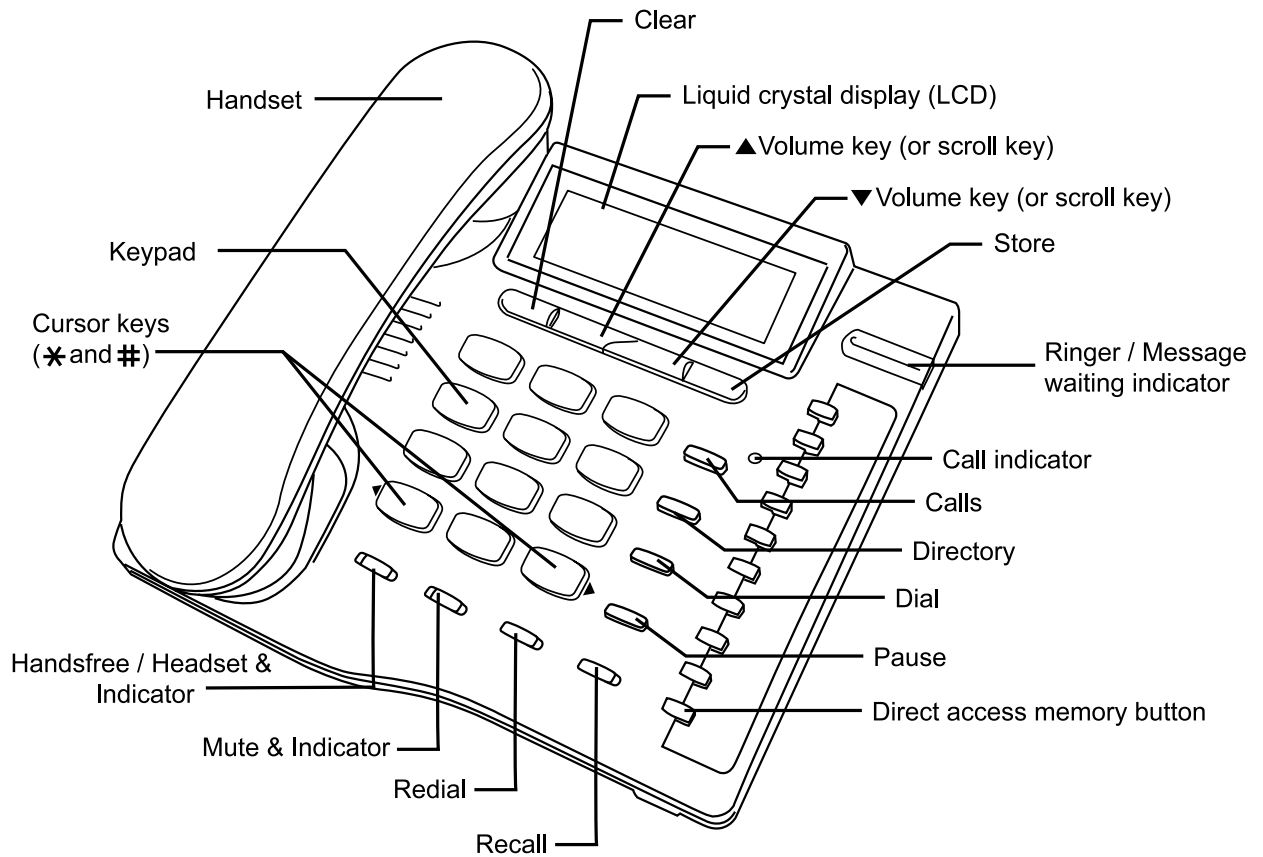

FIGURE 2A: TOP VIEW

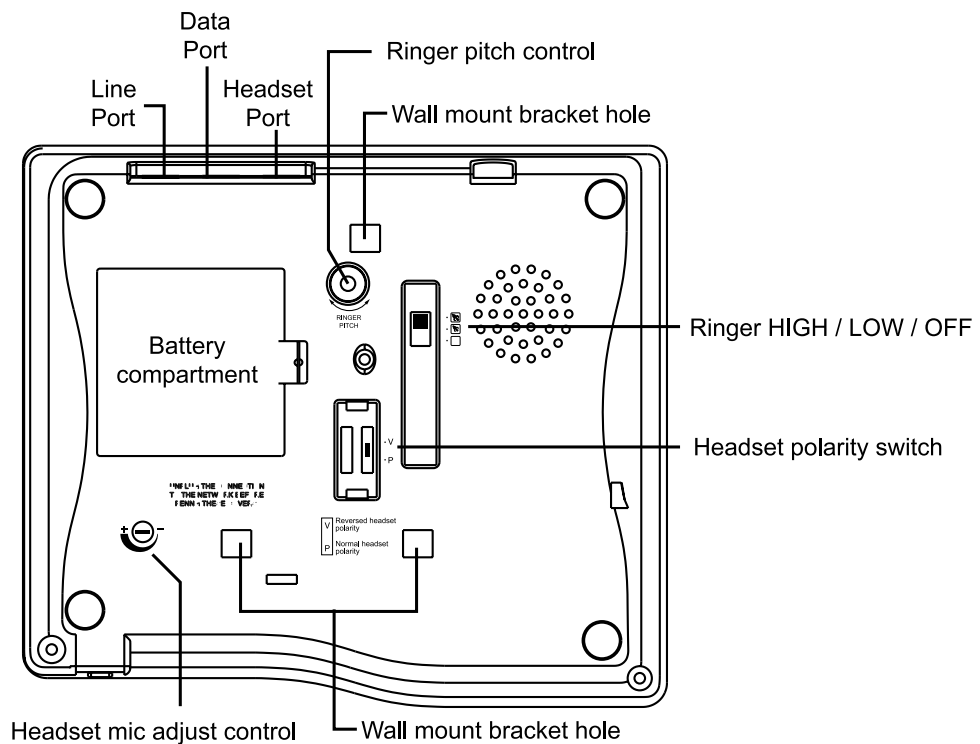

FIGURE 2B: BOTTOM VIEW

RINGER/MESSAGE WAITING INDICATOR

Located at the top right hand side of the telephone above the display, the red lense contains two different indicators; their functions are as follows:

1. Ring Indicator Flashes when the telephone rings with an incoming call.
2. PABX Message Waiting Indicator Illuminates when a message is waiting in your PABX voicemail system (depends on system compatibility). The built-in message waiting option suits any neon type (minimum 80 VDC) message waiting system and polarity reversal message waiting (other system types are available as optional extras). To determine which PABX type your IQ335 has been prepared to suit, check the telephone's underside for a label indicating that specific circuitry has been installed in your unit. If in doubt, contact Interquartz for further details. To retrieve your message, consult your voice mail system user guide.

IQ335 is also fitted with a message waiting indicator which is compatible with the voicemail features of Centrex networks (e.g. Telstra Customnet) and residential line voicemail systems (e.g. Telstra Home Messages 101 and MessageBank). There are indicators located in the CALLS Key and the display for these services and are described elsewhere in this manual.

RINGER VOLUME SWITCH

The three available positions allow selection Off (no sound), Low volume, and High volume of the telephone ringing sound during an incoming call (Figure 2B).

RINGER PITCH CONTROL

The pitch of the ringing sound may be altered by rotating the control to suit your preference to achieve a distinctive sound, or one that is audible, more distinctive or more pleasant.

ALPHA-NUMERIC KEYPAD

In addition to normal dialing, the alphabetic characters are provided on the keys to enter names in the Direct Access and Directory memories as well as any online applications that require alphabetic keystrokes.

RESET BUTTON

Press to restore normal operation of the telephone in case of a malfunction or lock-up. The memories will not be erased when this button is pressed.

The RESET button should also be pressed when the Memory Protect Switch (illustrated) is moved to a new setting.

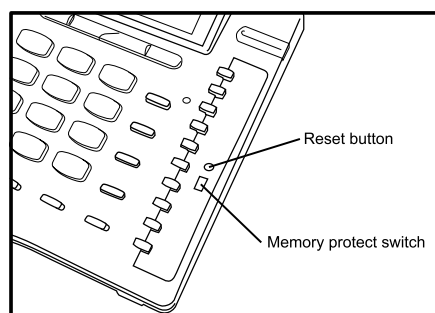

CRADLE SWITCH

Located in the handset cradle, this plastic lever is depressed by the handset (when placed in the cradle) to cut off the line. Note: Depressing this cradle lever too briefly when intending to terminate a call may result in an accidental “hookflash” that will inadvertently place the call on hold - this is known as “phantom calls” because the held call may ring again at your extension within a few minutes (the other party will have hung up, so it will seem as if you were called by a phantom, hence the name “phantom calls”). If you experience this problem, when terminating your call please depress the cradle lever a little longer before making/receiving your next call (i.e. phantom calls are not a system or telephone fault).

VOLUME ▲ and VOLUME ▼ KEYS

Used to adjust the hearing level of the handset earpiece, the handsfree speaker and the headset. To adjust the volume, press the VOL+ (▲) and Vol- (▼) buttons located under the display (see Figure 2A). Adjustment during a conversation will not be detected by the other party.

RECALL KEY

For use with a host system to invoke special system or network facilities such as call-hold or call transfer which may be available in your network. It is sometimes referred to as the “Flash” key or “Facility” key. To learn how to use it, please consult your telephone host system manual. Recall timing is preset to 100ms. The Recall timing setting affects the Recall key’s ability to function correctly with your system (see the Installation section regarding this setting).

REDIAL KEY

Press to redial the last number dialed, which may be up to 32 digits long. When pressed while still on-line, the telephone will clear the call and retry the number. It can be used in Handset, Handsfree, and Headset modes. Dialing more than 32 digits during one call will cause erasure of the entire number from the Redial memory.

See further details of the 5-stack Last Number Redial memory in section 6 “Memory Operation”.

To redial last number

1. Lift Handset, or press HANDSFREE/HEADSET
2. Press REDIAL (telephone redials last number).

To direct redial the last number

1. Lift Handset, or press HANDSFREE/HEADSET
2. Dial a number, [unsuccessful]
3. Press REDIAL; the telephone will automatically clear and re-connect the line; the number will be re-dialed.

PAUSE FUNCTION

The Pause command may be needed if your phone is connected to any network where a momentary pause is required (e.g. a PABX between internal and external dial tones).

For manual dialing:

1. Lift Handset
2. Dial any digits required before the pause
3. Press PAUSE; the telephone will complete the dialing process once the Pause time has elapsed
4. Dial the remaining digits.

The Pause function can be stored in any Direct Access or Direct memories. See section 8 for further details.

MUTE KEY AND INDICATOR

When pressed, it cuts off transmission from the handset, headset and handsfree microphones to allow user privacy. The red light indicates when the mute condition is active. Press MUTE again to release the mute condition.

HANDSFREE/HEADSET KEY AND INDICATOR

The HANDSFREE/HEADSET key has an auto-detection function; which disables the handsfree mode when a headset is in use. When the HANDSFREE/HEADSET key is pressed, a red indicator will glow to show that the handsfree or headset mode is activated. Press the key again to turn it off.

To use Handsfree mode

Ensure that a headset is NOT connected to the headset jack. Press the HANDSFREE/HEADSET key; the telephone will automatically operate in Handsfree mode. A red indicator will glow to show that the Handsfree mode is activated. Press the key again to turn it off.

To use Headset mode

Connect a headset to the headset jack. Press the HANDSFREE/HEADSET key; the telephone will automatically operate in Headset mode. A red indicator will glow to show that the Headset mode is activated. Press the key again to turn it off.

CURSOR ◀ AND ▶ KEYS

The Cursor functions of the * and # keys can be used when it is necessary to use the same key twice in succession when entering text and they also serve as Edit keys during memory storage.

AUTOMATIC CALL TIMER

When a call is in progress, the word TIMER appears on the display, and the time will count from 00:00. To use the timer as a call timer, the telephone will automatically enter the Timer mode when commencing a call. The call duration will be displayed for 10 seconds after the call is terminated.

DATA PORT

The Data Port provides access to the telephone line for computers (with a modem), answering machines and cordless phones.

BATTERY COMPARTMENT

As a precaution against the potential for a temporary interruption of mains power to affect the progress of any ongoing call, 3 x AA alkaline batteries can be fitted to the compartment. They can provide up to one month's support of all functions while mains power is absent, and battery power will not be consumed while mains power is present. If batteries have been fitted, it is recommended that they be routinely replaced before the "best before" date indicated by the battery manufacturer (consult the packaging or check on the battery).

DISPLAY ICONS AND FIELDS

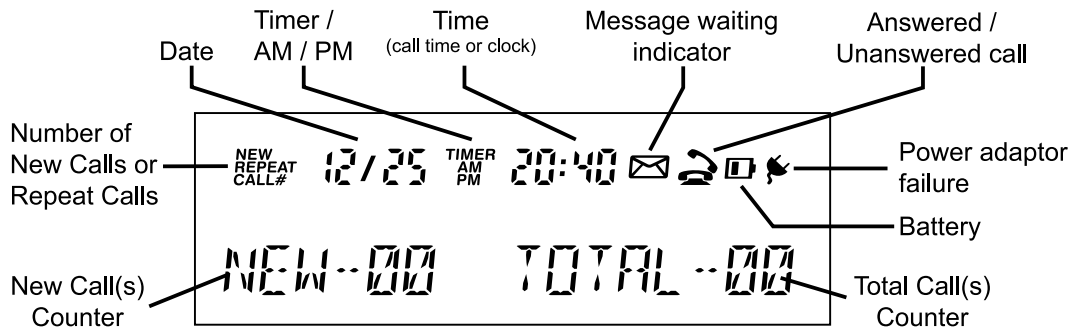
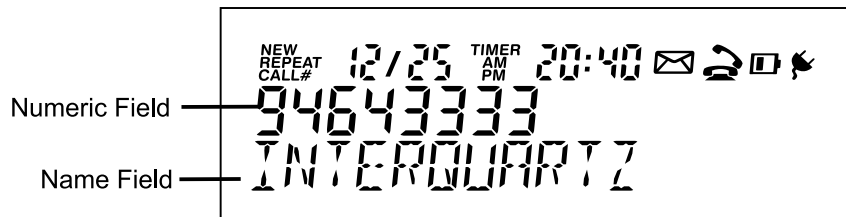

FIGURE 3A: DISPLAY IN IDLE STATE



**FIGURE 3B: TYPICAL DISPLAY APPEARANCE WHEN SHOWING
DETAILS OF A CALL**

NEW REPEAT CALL#

Received Call Status indication;

NEW - new calls have been received that have not previously been reviewed in the Calls list (the Calls key will also be flashing)

REPEAT - indicates multiple calls have been received from the same caller in the current Calls list's history; therefore please note that only the most recent call from that caller's number will be retained in the Calls list.

CALL # - entry number in Calls list

02/25

Date in Month/Day format; shows current date or date of received call when reviewing Calls list

TIMER

Indicates Call Timer is active

AM
PM

For the clock readout and when reviewing the time that a call arrived in the Calls list (displays only in 12 hour mode)

20:40

Hour:Minute format for the clock readout and when reviewing the time that a call arrived in the Calls list (displays only in 12 hour mode)

10:40

Minute:Second format in Call Timer mode (maximum count 99:59)



Displays together with "MESSAGE WAITING" text in the name field; to indicate the presence of message waiting in voicemail system (see "Message Waiting Light Compatibility" section)



Indicates, when reviewing the Calls list, that the call was answered on the IQ335



Indicates, when reviewing the Calls list, that the call was NOT answered on the IQ335



If this symbol is visible, the 3 x AA Alkaline batteries in the battery compartment should be replaced



Will be displayed in the absence of the adaptor power (only functions if batteries are also fitted and are in good condition)

Number

16 digits for displaying telephone number

Field

Name

16 characters for displaying caller name or number of new calls and total calls received.

Field

4. HANDSFREE OPERATION

To commence a Handsfree call press HANDSFREE/HEADSET; the telephone will activate the line, and the speaker, and the indicator will switch on to provide confirmation. Dialing and speech can then commence. Pressing the key again will terminate the call. The Handsfree state is storable in the Direct Access memory keys – please see the MEMORY OPERATION section.

The Handsfree mode will be disabled if a headset is connected to the headset jack.

Incoming calls using Handsfree:

1. Telephone rings
2. Press HANDSFREE/HEADSET
3. Commence your handsfree conversation.

Outgoing calls using Handsfree (manual or memory dialing):

1. Press HANDSFREE/HEADSET
2. Dial required number or press desired memory key
3. Speak as necessary.

Changing from Handsfree to Handset during a call:

Lift Handset and resume your conversation; the handsfree function will switch off automatically.

Changing from Handset to Handsfree during a call:

1. Press HANDSFREE/HEADSET
2. Replace Handset
3. Resume your conversation in Handsfree mode.

HINTS FOR HANDSFREE OPERATION

As a courtesy, tell the other party that you are using the handsfree function. He/She may or may not want people other than you to hear the conversation. A quiet environment ensures best handsfree performance. When handsfree is used in a noisy room or near a noise generating device (for example, a TV set), all or part of the message may be interrupted and cannot be heard. To eliminate this problem, try to lower the noise level in the room.

During the handsfree conversation, your telephone will give priority to the person who speaks louder when both people are talking simultaneously. Speak **ONLY** after the other person pauses or stops.

If the other person complains about poor transmission, talk directly at your telephone and from a closer distance as necessary, or lower volume control.

If the operation of the handsfree feature is not correct, refer to the FAILURE TO OPERATE section.

5. HEADSET OPERATION

The IQ335 can be configured to suit many different headsets - please consult the INSTALLATION section for details to get the best performance from your headset.

BASIC OPERATION

To make or receive call using the headset:

1. Press HANDSFREE/HEADSET
2. If you are making an outgoing call, dial the required number
3. To revert from Headset mode to Handsfree mode during a call from Headset mode, unplug the headset
4. Speak as necessary
5. To hang up, press HANDSFREE/HEADSET

HEADSET/HANDSET/HANDSFREE MODES

A call can be switched between modes as follows:

1. To revert to Handset mode from Headset mode, lift Handset
2. To revert back to Headset mode during Handset mode, press HANDSFREE/HEADSET.

TRAINEE/SUPERVISOR MODE

Allows the handset and headset to be used in tandem. This will enable a supervisor to monitor a trainee's progress during a call, or "take over" a call. The following procedures assume that the trainee is wearing the headset and a call is in progress.

1. During a trainee's call the supervisor may lift the Handset (Handsfree/Headset indicator will turn off)
2. Quickly press HANDSFREE/HEADSET and the indicator will illuminate
3. The trainee may continue the conversation with the supervisor only listening to the call.

Silent Ringing

Designed for call centres or any application where call-related noise is to be kept to a minimum, this feature allows incoming calls to ring silently; the operator is aware of the incoming call, but the telephone does not add to the room noise even when ringing.

To use the telephone in Silent Ringing mode:

1. Set the Ringer Volume switch to the Off position (signified by the square symbol without a bell symbol inside it)
2. Put your headset on and wait for the next incoming call
3. When a call arrives, the Ringer/Message Waiting Indicator will flash and the operator will hear the ringing tone at a low level in the headset
4. Press HANDSFREE/HEADSET to answer the call.

ALERT LIGHT SUPPORT

The IQ335 is designed to support the “Alert Light” available on some headsets. When pressing HANDSFREE/HEADSET on the telephone, the “Alert Light” indicator on the headset will be illuminated, signifying that the user is on a call. This feature can be used effectively in call centre applications so that the user’s colleagues will be aware that the user has a call in progress.

6. MEMORY OPERATION

MEMORY STORAGE

Model IQ335 has 20 Direct Access memories, 100 Directory memories, 80 incoming call Calls list and 5 Last Number Redial memories. All memories have a maximum 32 digits capacity and 16 characters name capacity. 10 memories can be protected for special applications.

Memory Backup

No batteries are required. The Calls list, Direct Access and Directory memories are non-volatile (no batteries needed to retain contents in the event of power failure).

Memory Storage

Storage operations can be carried out either with the adaptor connected or with batteries installed.

To enter letters for name entries, use the letters marked on the keys. For example, press key 7 (P, Q, R, S) once to enter P, twice to enter Q and so on. To make a space when entering in the name field, press the right hand ► (#) Cursor key.

To commence a storage procedure, lift the Handset or press HANDSFREE/HEADSET before commencing the procedures described for storing numbers and names as described below. To delete any incorrect digits while storing, use the cursor keys (◀ and ▶) to move to the unwanted character and press CLEAR.

DIRECT ACCESS MEMORY KEYS

The IQ335 has 20 Direct Access speed-dial memories accessible via 10 keys arranged on the right hand side of the top panel (see Figure 2A). These keys each have five “one-touch” memories and five “two-touch” memories. The one-touch memories are accessed by pressing the key once briefly during the storage or retrieval procedures described in this manual. The two-touch memories are accessed by pressing the same memory key twice in quick succession.

The Direct Access memories are very useful for storing some of your favourite network facility codes (e.g. Diversion, Call Forward, Call Back etc). Consult your system user guide for the codes that you need to store so you can activate these functions once they have been stored in the IQ335 Direct Access memory keys.

Direct Access Memory Capacity

Each memory can store up to 32 digits including Pause, * , # , Recall (Flash) and a special Handsfree code.

Speed-Dialing (Storable Handsfree code)

When storing a number, you can add a “Handsfree” command to the start of the number. It appears as an “H” on-screen. This programming technique makes dialing faster and easier – to commence dialing of any Direct Access memory programmed with a “Handsfree” code the memory key can be pressed without the need to lift the handset or press the HANDSFREE/HEADSET key. The Handsfree code is entered by pressing the HANDSFREE/HEADSET key before the number being stored.

Speed-Dialing and Automatic Hang-up

The Handsfree code may also be stored in a Direct Access memory key at the trailing end of a stored number to make the telephone hang up immediately after dialing the number. The Pause character can be used to extend the time before hang-up by entering it in the stored string after the digits and before the last "H".

Note: "H" represents the Handsfree code and "nnnnn" represents any subsequent digits to be dialed).

Example 1. If H is entered before the digits to be dialed: the phone will go on-line in Handsfree mode and dial out the subsequent number. Phone will remain on-line in Handsfree mode until the user manually hangs up.

Example 2. If H is entered at both ends of the digits to be dialed: the phone will go on-line in Handsfree, dial out the number and go off-line again.

To view the contents of a Direct Access memory

Press the desired Direct Access memory key (press once to view a one-touch memory or twice to view a two-touch memory); the display will show the number & name

Note: If the memory being viewed has been programmed with the "Handsfree" ("H") prefix, the telephone will commence dialing the number.

To store a Number and Name in a Direct Access memory

1. Press STORE; the display will show "STORE"
2. Press the memory key either once to store in a one-touch memory or twice for a two-touch memory; the display will show "ENTER NUMBER"
3. If you wish to setup the chosen memory key as a speed-dial key, go to step 4. Otherwise go to step 5
4. Press HANDSFREE/HEADSET; the display will show "H" in the number field. If this is not required, go to step 5 without pressing HANDSFREE/HEADSET
5. Enter the telephone number and press STORE
6. Enter the name by using the keypad and press STORE to confirm; the display will show "MEMORY STORED".

To dial from a Direct Access memory

Speed-dial memory (i.e. the memory key has been programmed with an "H" preceding the number as described above):

Press the desired memory key either once to dial from its one-touch memory or twice to dial from its two-touch memory.

Non Speed-dial memory (i.e. the memory key has NOT been programmed with an "H" preceding the number as described above):

Press the desired memory key either once to dial from its one-touch memory or twice to dial from its two-touch memory.

Direct Access Memories and the Memory Protect Switch

The Memory Protect switch protects the 5 uppermost Direct Access memory keys to prevent them from being overwritten by the user. This allows pre-set functions to be allocated to them for large user groups. The Memory Protect switch is located underneath the Direct Access memory card (see Figure 4).

It is recommended that some of the 10 Direct Access memories be programmed to create network features access keys to store some of your favourite network facility codes (e.g. Diversion, Call Forward, Call Back, etc.). This will enable more convenient access to these features without the need to remember the necessary codes. The memory card paper insert can be used to label the keys to indicate their new functions (i.e. the name of the network feature). Consult your system user guide for the codes that you need to store.

If some of your Direct Access memory keys are locked and prevent storage of new numbers this may be due to the presence of pre-programmed codes chosen by your system administrator. Before moving the switch to the “Non-Protected” position we recommend that you contact your system administrator, Interquartz or your dealer to discuss if they can be unlocked. Changing the switch setting may allow any pre-programming to be lost.

To program or alter the contents of a protected Direct Access memory:

1. Remove the Direct Access memory card paper insert and clear plastic cover to reveal the Memory Protect Switch (see Figure 4)
2. Move the Memory Protect Switch to the “Non-Protected” position as shown in Figure 4
3. Press the Reset button
4. Press STORE; the display will show “STORE”
5. Press the memory key either once to store in a one-touch memory or twice for a two-touch memory; the display will show “ENTER NUMBER”
6. Enter the telephone number and press STORE
7. Enter the name (name of the feature code or destination) by using the keypad and press STORE to confirm; the display will show “MEMORY STORED”
8. Move the Memory Protect Switch to the “Protected” position as shown in Figure 4
9. Press the Reset button
10. Replace the Direct Access memory card paper insert and clear plastic cover.

To dial from a Protected Direct Access Memory

Press the desired memory key either once to dial from its one-touch memory or twice to dial from its two-touch memory.

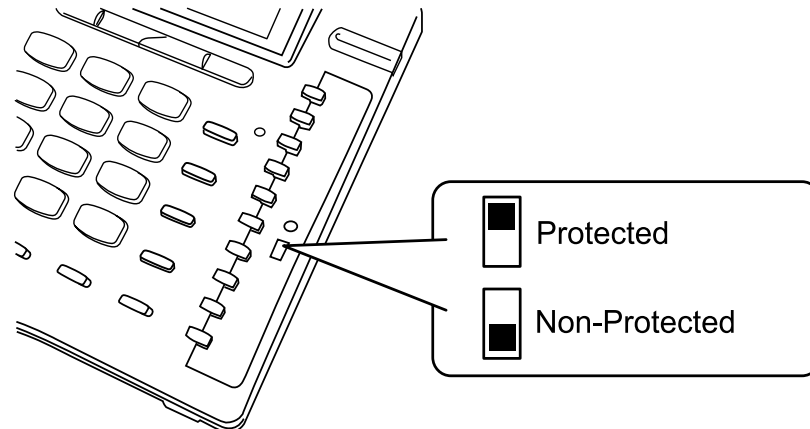

FIGURE 4: MEMORY PROTECT SWITCH

DIRECTORY MEMORY

The Directory memory works like the memory of a typical mobile phone, with the storage of names with numbers and name searching capability. The keys on the keypad allow the entering of alpha and numeric characters in the name field.

If your network does not send caller name information in conjunction with the caller's number, the ability of the IQ335 to display the caller's name during an incoming call will be dependent on the caller's number matching a number already stored in the Directory memory. Therefore, at the time of installation it may be useful to store names and numbers of friends, business associates and other regular callers into the Directory memory to take immediate advantage of the name display feature. In addition, the Calls list can be used as a convenient source of programming data – the details of any previous incoming calls found in the Calls list can be stored in the Direct Access memory keys and/or the Directory memory by a simple transfer process, thereby reducing key strokes and eliminating potential error that may otherwise result during manual storage of the same details. Please see the sections entitled "To store a caller's details in a Direct Access memory from the Calls list" and "To store a caller's details in the Directory memory from the Calls list" located in the CALLER ID OPERATION section.

Scrolling (▲ ▼) and Editing (◀ ▶) keys

When reviewing any lists on the display (such as stored names and numbers), the ▲ key (also labeled "Volume +") and the ▼ key (also labeled "Volume –") key serve as scrolling keys to move up and down the lists.

To edit any errors during Memory Storage or whenever it is necessary to use the same key twice in succession when entering text, the ◀ key and ▶ can be used to move the cursor.

Directory Memory Capacity

The Direct Access memory can store up to 100 names & numbers. When the memory is full, the display will show "DIRECTORY FULL".

To Store a Number and Name into a Directory memory

1. Press STORE; the display will show "STORE"
2. Press DIRECTORY; the display will show "ENTER NUMBER"
3. Enter the telephone number, then press STORE; the display will show "ENTER NAME"
4. Enter the name by using the keypad
5. Press STORE; the display will show "DIRECTORY STORED".

If the telephone number and name being stored match a previous entry, the display will show "DIRECTORY EXIST" and the new entry will not be stored.

To dial from the Directory memory using Name Search

1. Press DIRECTORY, the first entry in the directory will be displayed
2. Enter the first alpha-numeric character of the name you wish to dial
3. Scroll (press ▲ or ▼) to find the name
4. Press DIAL to dial it out.

To edit an entry in the Directory memory

1. Press DIRECTORY; the first entry in the directory will be displayed
2. Scroll (press ▲ or ▼) to select the entry you want to edit
3. Press STORE, the first digit of the telephone number will begin to flash
4. Move the Cursor (by using ◀ or ▶) to navigate to the digit(s) to be changed and make the necessary changes
5. Press STORE to confirm
6. The first letter of the name will flash; move the Cursor (by using ◀ or ▶) to navigate to the letters to be changed. Make the necessary changes
7. Press STORE to confirm; the display will show "DIRECTORY STORED".

To delete an entry from Directory memory

1. Press DIRECTORY; the first entry in the directory will be displayed
2. Scroll (press ▲ or ▼) to select the entry you want to delete
3. Press CLEAR twice briefly, the display will show "ERASED".

Caution: If CLEAR is pressed continuously for 6 seconds in the above procedure, the entire directory list may be deleted.

LAST NUMBER REDIAL MEMORY

The Last Number Redial memory contains your 5 most recently dialled outgoing numbers, with a maximum of 32 digits each. The scroll keys (▲ or ▼) allow you to navigate through the list to select the number that you wish to redial.

Using the 5-Stack Last Number Redial Memory

1. To dial the most recently dialled number, press REDIAL. If you require an earlier number go to step 2, otherwise proceed to step 3
2. Scroll (press ▲ or ▼) to select a number from the 5 redial memories. The most recently dialled number will be identified as “REDIAL 1” on the display, and the earliest as “REDIAL 5”.
3. Press DIAL to dial the selected number.

See REDIAL KEY section details of the Direct Redial Function

7. USING THE CALLER ID DISPLAY

This section assumes that you are using the IQ335 in a network that is capable of supplying Caller ID data in the Bellcore GR-30-CORE format. In addition, you may need to request or subscribe to Caller ID and Call Waiting services from your network provider before Caller ID data will be sent by the network. For details, please contact your service provider.

When an incoming call is received, information including the caller's name, number, call date & time will be transmitted to your Caller ID Display Telephone between the first and second rings from the network. While the incoming call is ringing, the IQ335 compares caller's ID to all stored numbers – if a match is found it will display the name that you have stored with that number.

As incoming calls may contain an area code and the number, a match will not be found if you store a local number without the area code. The probability of a match may be enhanced if the area code is stored with every number. Some types of calls such as International calls, payphone calls and withheld calls may not send any Caller ID data.

Caller ID during a typical incoming call

1. The Ringer sounds and the Ringer Indicator will flash
2. After about 1 second, the caller's information is shown on the display
3. If the call is not answered, the caller's information will be kept on the display for a further 10 seconds after the last ring; and the Calls key (New Call) indicator will flash. The caller's number can be up to 16 digits long, and the name can be up to 16 characters long before exceeding the capacity of the display
4. The details of the call will be stored in the Calls list.

Displaying the caller's name during an incoming call

The caller's name will be automatically displayed if:

- a) the name information is delivered by your telephone service in conjunction with the caller's number, or
- b) if the number matches a number stored in the Direct Access or Directory memory.

At the time of installation it may be useful to store names and numbers of friends, business associates and other regular callers into the Directory memory to take advantage of the name display feature.

In addition, the Calls list can be used as a convenient source of programming data – the details of any previous incoming calls found in the Calls list can be stored in the Direct Access memory keys and/or the Directory memory by a simple transfer process, thereby reducing key strokes and eliminating potential error that may otherwise result during manual storage of the same details. Please see the relevant sections entitled "To store a caller's details in a Direct Access memory from the Calls List" and "To store a caller's details in the Directory memory from the Calls List".

CALL WAITING DISPLAY

The IQ335 can display the details of a current caller while you are already on a call. To enable the Call Waiting feature, you may need to request or subscribe the call waiting service from your network provider. For details, please call your service provider.

Note: It is not recommended to use more than two Caller ID phones in parallel on the same line as their performance may be affected. For example, Caller ID display of a second call while you are off-hook (i.e. Call Waiting Caller ID, sometimes known as "Type 2 Caller ID") may not be received by the IQ335 if another parallel connected Caller ID phone is in use and off hook in party line fashion on the same call.

Calls list

The IQ335 stores the details of all incoming calls in a Calls list, which is accessible by pressing the CALLS key. The Calls list can store up to 80 caller records, and when it has reached its full capacity the oldest record will be removed to accommodate the new call.

Scrolling (▲ ▼) keys

When reviewing any lists on the display, the ▲ key (also labeled "Volume +") and the ▼ key (also labeled "Volume -") key serve as scrolling keys to move up and down the lists.

To view the Calls List and dial a Number in the Calls List

1. Press CALLS to display the most recent incoming call; if there is no entry in the Calls list, the display will show "NO ENTRIES"
2. Scroll down (press ▼) to move on to the previous call; subsequent presses will display successively earlier calls
3. To dial any displayed number; press DIAL
4. If the end of the Calls list is reached, the display will show "END OF LIST"; you may continue to scroll up (▲) or down (▼) to review the list again
5. If you choose not to dial any number from the Calls list, the DISPLAY will revert to clock mode in 10 seconds.

A typical call displayed from the Calls list is depicted in Figure 5.

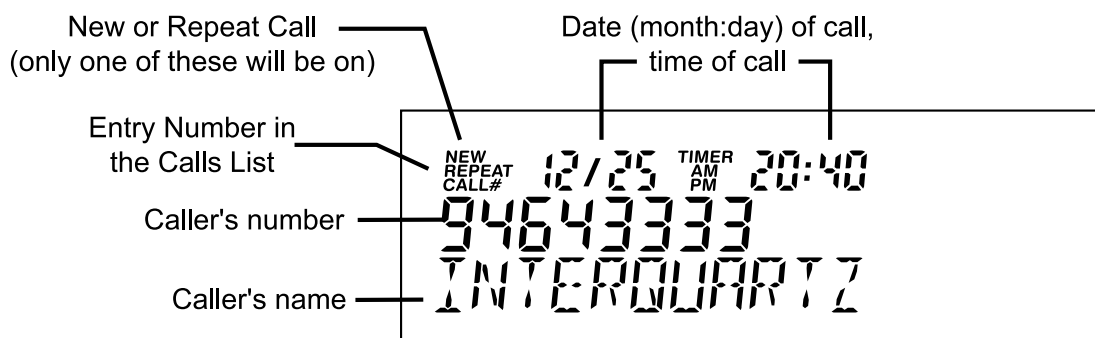

FIGURE 5: DISPLAY OF A TYPICAL CALL FROM THE CALLS LIST

When reviewing the Calls list, you may see the following details:

“OUT OF AREA”	a caller’s network does not offer the Caller ID service or the call is from an overseas caller or a payphone.
“PRIVATE”	a caller has blocked his/her number from being transmitted and displayed.
“LINE ERROR”	the telephone cannot recognise the information contained with the Caller ID message.

**NEW
REPEAT
CALL#**

NEW - new calls have been received that have not previously been reviewed in the Calls list

REPEAT - indicates multiple calls have been received from the same caller in the current Calls list’s history; therefore please note that only the most recent call from that caller’s number will be retained in the Calls list.

CALL # - entry number in Calls list

02 / 25

Date in Month/Day format; shows current date or date of received call when reviewing Calls list

**AM
PM**

Timer - indicates Call Timer or Stop Watch mode is active

For the clock readout and when reviewing the time that a call arrived in the Calls list (displays only in 12 hour mode)

20 : 40

Hour:Minute format for the clock readout and when reviewing the time that a call arrived in the Calls list (displays only in 12 hour mode)



Indicates, when reviewing the Calls list, that the call was answered on the IQ335



Indicates, when reviewing the Calls list, that the call was NOT answered on the IQ335

To store a caller's details in a Direct Access memory from the Calls List

1. Press CALLS; the most recent incoming caller's name and number will be displayed
2. Scroll (press ▲ or ▼) to select the number you want to save into the Direct Access memory
3. Press STORE; the display will show "STORE"
4. Press a memory key; the display will show "ENTER NUMBER" below the telephone number
5. Press STORE to confirm. Move the Cursor (press ◀ or ▶) to edit the number before saving
6. The display will show the caller's name; press STORE to confirm. Move the Cursor (press ◀ or ▶) to edit the name before saving
7. The display will show "MEMORY STORED".

To store a caller's details in the Directory memory from the Calls List

1. Press CALLS; the most recent incoming caller's name and number will be displayed
2. Scroll (press ▲ or ▼) to select the number you want to save into the Directory memory
3. Press STORE; the display will show "STORE"
4. Press DIRECTORY; and the display will show "ENTER NUMBER" below the telephone number
5. Press STORE to confirm. Move the cursor (press ◀ or ▶) to change the number before saving
6. The display will show the caller's name; move the cursor (press ◀ or ▶) to edit the name if necessary
7. Press STORE to confirm; the display will show "DIRECTORY STORED".

To delete a Call from the Calls List or to delete the entire Calls List

1. Press CALLS and Scroll (press ▲ or ▼) to find the entry you wish to delete
2. To erase the displayed call, press CLEAR twice in rapid succession; the display will show "ERASED"
3. To erase the entire Calls list, press CLEAR twice in rapid succession and hold the key down on the second depression; the display will show "HOLD TO CLR CALL"
4. To prevent entire directory erasure release the CLEAR key at this time before 6 seconds has elapsed; otherwise keep holding the key down and go to the next step
5. 6 seconds from step 3 the directory will be deleted and the display will show "CALL MEM CLEAR".

Note: See MEMORY OPERATION section for more details of storing and dialing operations using Direct Access and Direct memories.

8. ADVANCED NETWORK OPERATION

Where this telephone is used on an intelligent network such as Easycall, Customnet, Centel, Spectrum, a PABX or any Centrex networks, the following information may be useful.

Message Waiting function in conjunction with Telstra's Customnet, Home Messages 101 services and MessageBank

The IQ335 has built-in compatibility with the above services. When the Message Waiting signal is received:

1. the CALLS indicator key will flash
2. the display will show the words "Message Waiting" in the name field
3. the display will show an envelope icon.

Manually Resetting the Message Waiting Prompts

The message waiting prompts as described above are normally controlled by the network to switch on and off as needed. If at any stage the telephone is found to be incorrectly indicating a Message Waiting condition, the erroneous indication can be cleared manually. To clear the MWI prompts; press CLEAR twice.

"Talking Text" SMS Messages

The IQ335 is compatible with the "Talking Text" SMS service. To access messages, please refer to the guidelines issued by your service provider.

HOLDING AND TRANSFERRING CALLS

The RECALL key's functionality is dependent on your system type, so please check your system's extension user guide to find out how to use the RECALL key. It is sometimes known as the Flash or Facility key. The Installation section contains information regarding settings that can affect the RECALL key's compatibility with your system.

PAUSE FUNCTION WHEN DIALING OUT

Sometimes a pause is necessary either when dialing ordinary outgoing calls, accessing specialised network features or perhaps when storing certain numbers in the memory. If you have determined that a pause is required by your host system, or if you have already experienced dialing difficulties, please review the information below.

AUTOMATIC TRUNK ACCESS DIGIT INSERTION

When the telephone is used wherever a dialing prefix is required to make an external call (e.g. normally 0 is needed for an outside line), this prefix can be stored to ensure that it is automatically dialled whenever an external number is dialled from the Calls list. This resolves a problem found in Caller ID capable network environments where the caller ID information delivered to the receiving telephone does not contain the outside line prefix necessary to complete a call-back to that caller.

To setup, model IQ335 accepts a one or two digit Trunk Access Code as follows:

1. Press STORE
2. Enter the Trunk Access digit (example, 0 for Customnet)
3. Press STORE
4. Press “ * ”

After programming digit 0 in the above example the unit will insert a 0 in front of any outgoing number that is dialed from the Calls list (the list of incoming calls).

This setting remains set until the user changes it - removal of power sources or line connection will not change the setting.

Automatic pause insertion

The above procedure will also insert a pause after the access code before dialing the actual number that has been selected for call-back from the Calls list. The pause time can be pre-set (see below).

PAUSE TIME

Sometimes the standard Pause time of 1 Second may be inappropriate, such as when a shorter pause is needed to slow down a code stored in memory so that the telephone does not dial too quickly for the network.

EXAMPLE: A particular network typically needs a short pause in the Call Hold function code after “Recall” is sent to line and before “ * 74” is dialed. A pause time of 200mSec is required in that code sequence. The required Call Hold code is Recall, Pause (insert multiple pause(s) here), * ,74.

Solution: Change the Pause time from the factory default of 1 Sec to 100mSec, and then program the memory with enough pauses inserted in the code to achieve the desired pause time.

FIRST change the pause time to 100mSec

1. Press STORE; the display will show “STORE”
2. Press # , * , STORE; the display will show “1-RECALL 2-PAUSE”
3. Press 2 to enter Pause Time Selection; the display will show “PAUSE 1 SEC” (the factory default Pause time)
4. Press Scroll (the one above the DIAL key) Up or Down to select 100mS
5. Press STORE to confirm selection; the display will show “PAUSE STORED”.

THEN program the Call Hold function code with 200mSec of Pause time (two 100mSec Pauses) as follows:

1. Press STORE; display shows “STORE”
2. Press any memory key; the display shows “ENTER NUMBER”
3. Press RECALL, PAUSE (twice), * , 74; the display shows “FPP * 74”
4. Press STORE; the display shows “ENTER NAME”
5. Enter text “CALL HOLD” on the keypad
6. Press “STORE”; the display shows “MEMORY STORED”
7. Test for resulting pause time stored in that memory key for network compatibility by pressing that memory key at the appropriate time and observing the result.

If two Pauses (i.e. 200mSec) do not produce a long enough post-Recall pause for the network switch, try three pauses (300mSec) or four (400mSec) or more.

The Pause time setting remains set until the user changes it - removal of power sources or line connection will not change the setting.

HOLDING AND TRANSFERRING CALLS

The method used for these functions is dependent on your system type, so you will need to check your system's extension user guide. The RECALL key is typically used to transfer calls and the Recall Timing setting affects the Recall key's ability to function correctly with your system (see below).

USING THE MEMORIES

Any combination of numbers, * and # , Pause, Recall and Handsfree commands can be stored. You may find it useful to store some of your favourite network facility commands in the telephone for fast, convenient access to those facilities (e.g. Diversion, Call Forward, Call Back etc). Consult your system user guide for the codes that you need to store. The Direct Access memories can be pre-programmed at point of sale with network feature codes. For further information, please refer to the "Memory Operation" and "Memory Protection Switch" sections of this manual.

Speed Dialing

When storing a number, you can add a "Speed Dialing" command to the start of the number. This makes dialing faster and easier. The "H" command, entered by pressing the HANDSFREE/HEADSET preceding the telephone number in the Memory Storage procedure, activates the handsfree function during dialing so that you can make a handsfree call just by pressing the memory key once it is programmed.

Cascade Memory Dialing

The contents of more than one memory can be "cascaded" or added together during a call to create a long dialing sequence by pressing the required memory keys in the desired order. This feature can be used to store unusually long numbers, which may exceed the digit capacity of any individual memory.

9. INSTALLATION

GENERAL SETTING-UP

1. Fit the coiled cord to the appropriate sockets in the handset and the telephone base - please do not connect it to the headset socket at the rear
2. Fit the line cord to the line socket and to your telephone network outlet
3. Set the Ringer Volume and the Ringer Pitch controls
4. See following sections to complete the installation
5. If using a headset, connect it to the headset jack shown in Figure 2B.

LINE CONNECTION

This telephone is supplied with a line cord and plug compatible with both 8 pin modular and 6 pin modular wall sockets , with the centre pair being used for all telephony functions. Other types of plugs and cords are available on request.

LOCATION

The telephone should be placed on a desk, table or shelf where it is not likely to be pushed off. If the unit is to be wall-mounted, it should be seated securely on the IQ335 Wall Mount Bracket illustrated in Figure 6B (please order separately). Avoid excessive heat, damp, dust, direct sunlight, vibration, and other appliances or devices which may transmit or emit electrical or electromagnetic radio frequency noise or signals (e.g. computers, welders, pagers).

WALL MOUNTING

Use the IQ335 Wall Mount Bracket or Wall Mount Kit No.4 shown in Figure 6B (please order separately).

1. To enable the Handset to be supported in the cradle, follow the procedure shown in Figure 6A to reverse the Handset Retainer
2. Connect the link cord as shown
3. Fit the IQ335 wall mount bracket (optional, not supplied) to the underside of the telephone and mount on the 7626 modular wall jack (see Figure 6B).

1. Use your thumb to press the HANDSET RETAINER

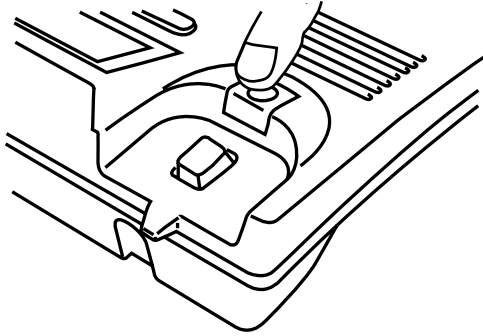

2. Push the HANDSET RETAINER out of the slot

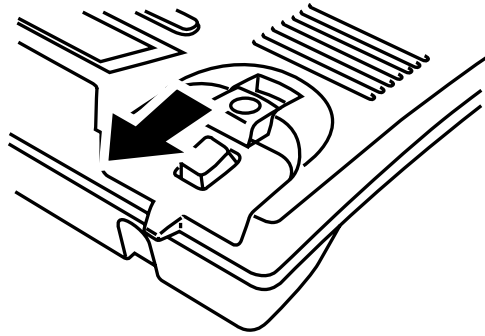

3. Turn the HANDSET RETAINER 180°

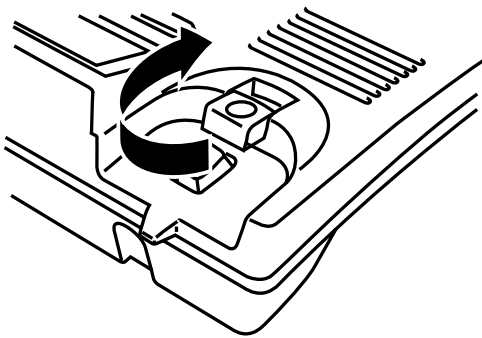

4. Insert the HANDSET RETAINER back into its slot

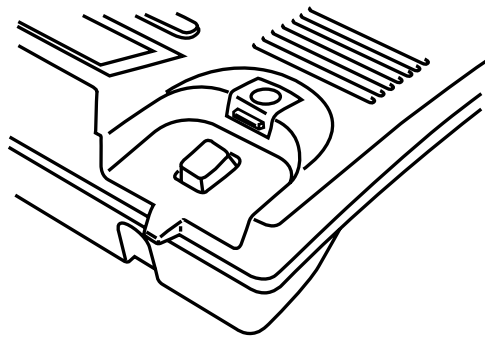

FIGURE 6A : WALL MOUNTING

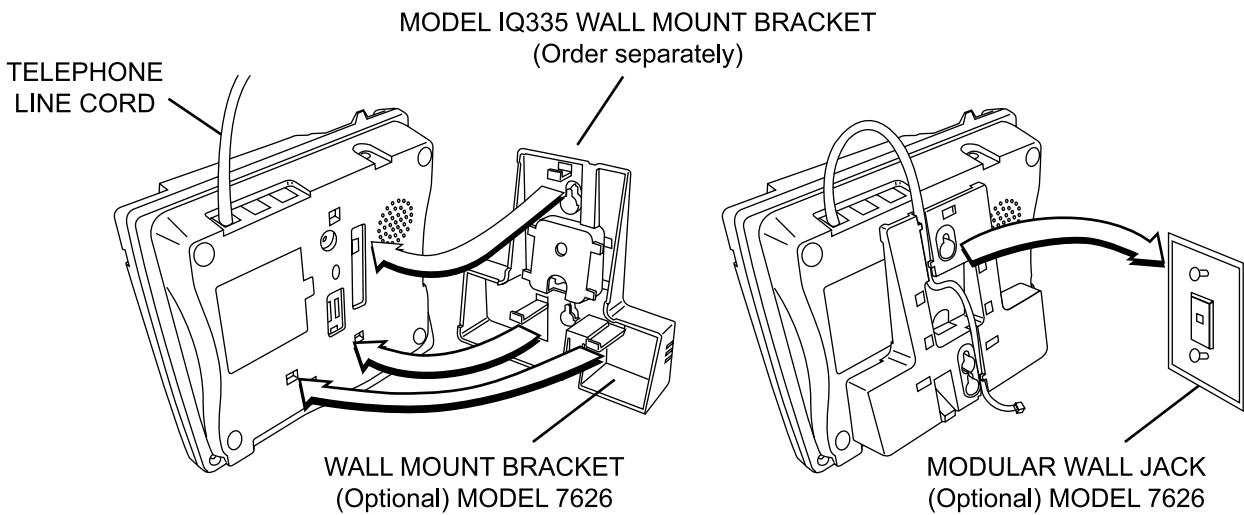

FIGURE 6B : IQ335 WALL MOUNT BRACKET. 7626 MODULAR WALL JACK AND LINK CORD

Note: The IQ335 Wall Mount Bracket, 7626 Modular Wall Jack and link cord illustrated in Figure 6B are available from your authorised Interquartz dealer and can be ordered together as Wall Mount Kit No.4.

TECHNICAL ADJUSTMENTS - FOR CORRECT OPERATION

RECALL TIMING SELECTION

Two recall timings are available – 100 milliseconds and 1 second. To select a Recall Timing

1. Press STORE; the display will show “STORE”
2. Press # and * then STORE; the display will show “1-RECALL 2-PAUSE”
3. Press digit 1 to enter Recall Timing selection; the display will show “RECALL 100MS” (it is the factory default recall time)
4. Press the Scroll key to select the desired timing. There are four different timings of 100, 200, 300 and 600 ms for selection
5. Press STORE to confirm selection; the display will show “RECALL STORED”.

MESSAGE WAITING LIGHT COMPATIBILITY

No installation settings are required to enable the feature. If you have a PABX system, the red lense in the top right hand corner will light when there is a message waiting. If the light does not function correctly, your IQ335 may need an optional circuit to be added to make it compatible with your system. If you have a Centrex system (e.g. Spectrum) the Calls key indicator and the “Mail” (envelope) icon will flash and “MESSAGE WAITING” will be displayed. To retrieve your message, consult your voice mail system user guide.

HEADSET MIC ADJUST CONTROL

This control allows many different headsets on the Australian market to function correctly with the IQ335 telephone by adjusting the headset microphone sensitivity. The control is located on the underside of the telephone (see Figure 7). The adjustment can be made by a small screwdriver or similar implement that will fit into the control slot. Please see Table 1 as a guide to the correct settings for some popular Headsets.

To make a Headset mic level adjustment

With the Headset connected as per the instructions in this manual:

1. Put the Headset on and lift the Handset to your other ear and make an outgoing call
2. Pressing the HANDSFREE/HEADSET key, swap between Handset and Headset modes (the indicator will illuminate when the headset is in use). Do this a few times while speaking to the other party by repeatedly pressing the HANDSFREE/HEADSET key while holding a conversation
3. Use the other party’s help to decide if your voice level is the same on the headset in comparison to the handset
4. If you sound too loud on the headset, reduce the microphone sensitivity (turn anti-clockwise) so that your voice level when using the headset matches that of the handset. Clockwise rotation increases the Headset Mic output level. Please see Table 1 as a guide to the correct settings for some popular headsets.

HEADSET POLARITY SWITCH

Located on the underside of the telephone (see Figure 7), this switch provides compatibility with the two commonly-used headset wiring standards.

Position “V” suits Plantronics Vista cords and other headsets wired in the same configuration (also known as “reversed” wiring mode).

Position “P” suits Plantronics P cords and other headsets wired in the same configuration (also known as “normal” wiring mode).

Please see Table 1 as a guide to the correct settings for most popular headsets.

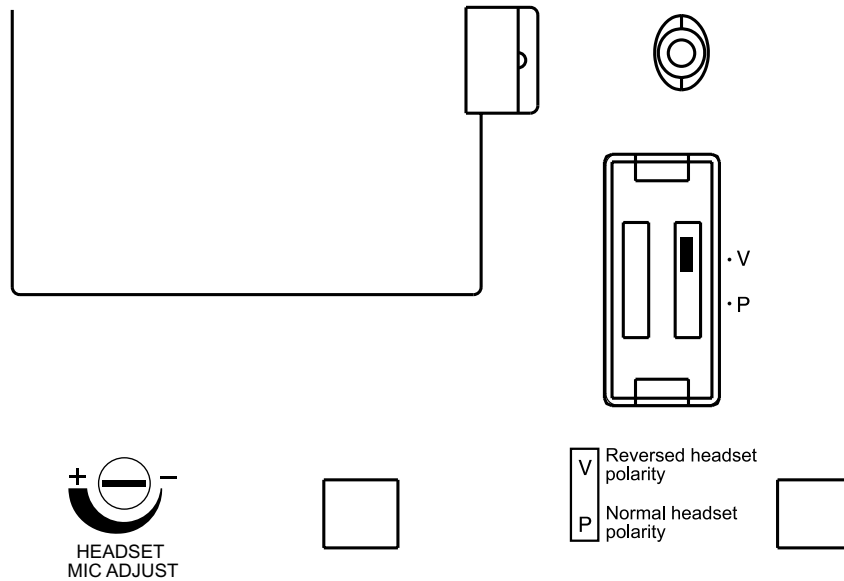





















FIGURE 7: HEADSET MIC ADJUST CONTROL AND POLARITY SWITCH

Headset Model	Headset Mic Adjustment Control	Headset Polarity Switch
ACS Orator	 50%	P
ACS stratos	 50%	P
Addcom Elite	 100%	P
Addcom Contour	 100%	P
BTC GHA-M201	 100%	P
BTC GHA M201N	 100%	P
Claria	 100%	P
Claria Alert	 100%	P
Crest II	 100%	P
GN Netcom Profile III Flex	 75%	P
GN Netcom Optima	 100%	P
GN Netcom Advantage	 100%	P
GN Netcom Shades	 100%	P
Plantronics H series with V cord	 100%	V
Plantronics P series with P cord	 100%	P
THW LS1-A	 100%	P
THW Crown	 100%	P
Unex Flexpro F100 NTN	 100%	P
Unex Flexpro F200 NTN	 100%	P
Please Note: Information above applies to headsets with cord, supplied for use without an amplifier.		

Explanation of Headset Mic Adjustment control settings in table:





-  100% = Fully Clockwise (loudest mic setting).
-  100% = Fully Anti-Clockwise (softest mic setting).
-  50% = Halfway (mid mic level)
-  75% = Three quarters Clockwise (loud mic level)

TABLE 1

10. GENERAL CARE AND MAINTENANCE

This telephone is a precision electronic instrument. While in use and storage, care should be taken to avoid rough handling, extreme temperature, and damp or dirty environments.

CLEANING

NEVER use aerosol sprays or other chemical agents or substances that leave a residue (furniture polish for example).

Use a mild detergent and a damp, clean cloth when cleaning. Do not allow moisture to enter the telephone interior - damage may result!

FAILURE TO OPERATE AND SERVICE DIFFICULTIES

If telephone service problems occur at any time, it is recommended that the installation procedure described in this manual be re-checked.

If a fault occurs, try to determine if the fault is with the telephone, or with the network or system to which the telephone is connected:

Disconnect the "suspect" telephone, and test the line with a substitute telephone. If the telephone service then operates satisfactorily, the fault is in the "suspect" telephone. Test the "suspect" telephone on a known good line. If the fault still occurs, the fault is in the "suspect" telephone.

Consult your Interquartz dealer for further advice if necessary.

11. THUNDERSTORMS

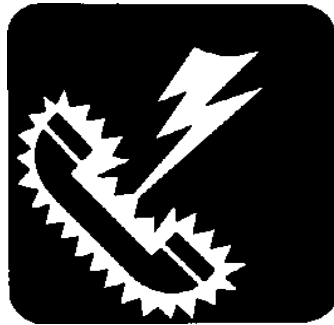

The telephone, in common with household electrical appliances, can be a source of electric and acoustic shock during thunderstorms. The possibility of a telephone user experiencing a shock is minimal. Nevertheless, customers should be aware of some simple precautions to follow during thunderstorms: Use your telephone only for calls of the utmost urgency. Keep these calls brief. Whilst using your telephone keep clear of electrical appliances and metal fixtures such as : stoves, air conditioners, refrigerators, window frames and sinks.

12. SERVICE

Please call 1800 6 IQTEL (1800 647 835) or email enquiries@interquartz.com.au from anywhere in Australia.

13. WARRANTY: 3 YEARS PARTS & LABOUR

Interquartz (A'Asia) Pty Ltd warrants the original purchaser against failure, under normal usage and in the environment and network for which it was designed, resulting from defective material and workmanship at time of manufacture for a period of THREE YEARS from the date of purchase. Interquartz reserves the right to require proof of purchase and proof of date of purchase to determine validity of this warranty. This warranty does not cover defects or damage due to normal wear and tear, negligence, accidents, exposure to radiation, misuse, obsolescence, incompatibility, improper maintenance, lightning strikes or unauthorised repairs or modifications and excludes freight or postage costs to/from your local authorised service centre unless otherwise arranged. Consequential loss not included. Notification of any defect must be made within the warranty period before a warranty repair can be effected. This guarantee is in addition to all other Warranties or Guarantees expressed or implied by the Trade Practices Act or other Commonwealth or State laws and all other obligations and liabilities on the part of Interquartz (A'Asia) Pty. Ltd.

Determination of Warranty Expiry

Every Interquartz IQ335 telephone carries a label that indicates the date of manufacture. The text on that label will follow the format "YYWW" where "WW" indicates the week number (52 weeks per year) and "YY" indicates the last two digits of the year. For example, "0511" would signify that the telephone was made during week 11 of 2005. The warranty stated above commences three months after this date in lieu of proof of purchase that supports any other commencement date.

Manufactured by
International Quartz Limited

A Subsidiary of Chiaphua Industries Ltd.

©Copyright INTERNATIONAL QUARTZ LTD. 2005