**HANDSFREE HEADSET
TELEPHONE
MODEL IQ360**



OPERATING INSTRUCTIONS

INTERQUARTZ®

CONTENTS

1. FEATURES	3
2. GENERAL CONTROLS AND INDICATORS	4
MULTIFUNCTIONAL INDICATOR LIGHT	5
RINGER PITCH CONTROL	6
RINGER VOLUME SWITCH	6
ALPHA-NUMERIC KEYPAD	6
CRADLE SWITCH	6
VOLUME SLIDER	7
RECALL KEY	7
HEADSET KEY AND INDICATOR	7
HANDSFREE KEY AND INDICATOR	7
MUTE KEY AND INDICATOR	7
BASIC OPERATION	7
REDIAL / PAUSE KEY	8
REDIAL FUNCTION	8
PAUSE FUNCTION	8
3. HANDSFREE OPERATION	9
HANDSFREE MICROPHONE	9
USING THE HANDSFREE KEY	9
CHANGING FROM HANDSFREE TO HANDSET DURING A CALL	9
CHANGING FROM HANDSET TO HANDSFREE DURING A CALL	9
OUTGOING CALLS USING HANDSFREE (MANUAL OR MEMORY DIALLING):	10
HINTS FOR HANDSFREE OPERATION	10
4. HEADSET OPERATION	11
CLARIA "ALERT" FEATURE	11
BASIC OPERATION	11
HEADSET /HANDSET/HANDSFREE MODES	11
TRAINEE/SUPERVISOR MODE	11
TRAINING MODE	12
SUPERVISOR MODE	12
SILENT RINGING FEATURE	12

5. ADVANCED NETWORK OPERATION	13
PAUSE FUNCTION WHEN DIALLING	13
HOLDING AND TRANSFERRING CALLS	13
USING THE MEMORIES	13
6. MEMORY FEATURE OPERATION	14
STORING A NUMBER	14
DIALING A NUMBER	14
CASCADE DIALING	14
MEMORY RETENTION	14
7. INSTALLATION	15
UNPACKING	15
SETTING THE FLASH TIME	15
GENERAL SETTING-UP	15
LOCATION	16
WALL MOUNTING	16
LINE CONNECTION	18
TECHNICAL ADJUSTMENTS - FOR CORRECT OPERATION	18
MESSAGE WAITING LIGHT COMPATIBILITY	18
HEADSET MIC ADJUST CONTROL	19
HEADSET POLARITY SWITCH	19
8. GENERAL CARE AND MAINTENANCE	22
CLEANING	22
FAILURE TO OPERATE AND SERVICE DIFFICULTIES	22
9. THUNDERSTORMS	23
10. WARRANTY - 6 YEARS	23
11. SERVICE CENTRES	24

1. FEATURES

- 6 YEAR WARRANTY
- 5 YEAR memory retention
- Handsfree operation for conference calling
- Built in headset socket to suit a wide range of headset types
- 10 one touch memory keys
- Adjustable Headset/Handset/Handsfree hearing level with slider volume control
- Mute Key and indicator – for privacy on both Handset, Handsfree and Headset mic
- Super bright LED ringer lamp allows visual ringing indication
- Headset Microphone level adjustment to suit all Headset types so both high gain and low gain Headset mics can be used
- Headset Cable Polarity Switch to suit both common (“normal” and “reversed”) Headset plug wiring modes
- Mid-call mode support (change between Headset, Handsfree and Handset during a call in any order)
- Trainee/Supervisor Mode allows both a Handset user and a Headset user to be online simultaneously without the need for a Headset training cord or adaptor
- “Silent Ringing” feature for Headset users allows the ringing to be heard in the Headset only (keeps call center noise levels down by eliminating the sound of ringing during incoming calls)
- Built-in support for Claria Alert headset “Alert” indicator light function
- Built-in switchable Message Waiting option to suit any neon (80 VDC) type message waiting system AND Ericsson BP250 Message Waiting (other system types optional)
- Large “In-use” indicator light to show when the user is on a call
- User selectable ringer volume and pitch
- Redial and Pause functions
- Switchable Recall facility with three flash time settings (100mS, 200mS, 600mS) to suit the host telephone system

- Compatible with direct lines, intelligent networks and PABXs
- Call Waiting compatible
- Telstra Customnet compatible
- Line powered, unaffected mains power interruption
- REN (Ringer Equivalence Number) = 0.68 allows multiple parallel devices on the same line without loading incoming ring
- Alpha-numeric keypad allows full access to services that require the entering of numerals and letters
- Fully modular connection provides maximum ease of installation on desk or wall

2. GENERAL CONTROLS AND INDICATORS

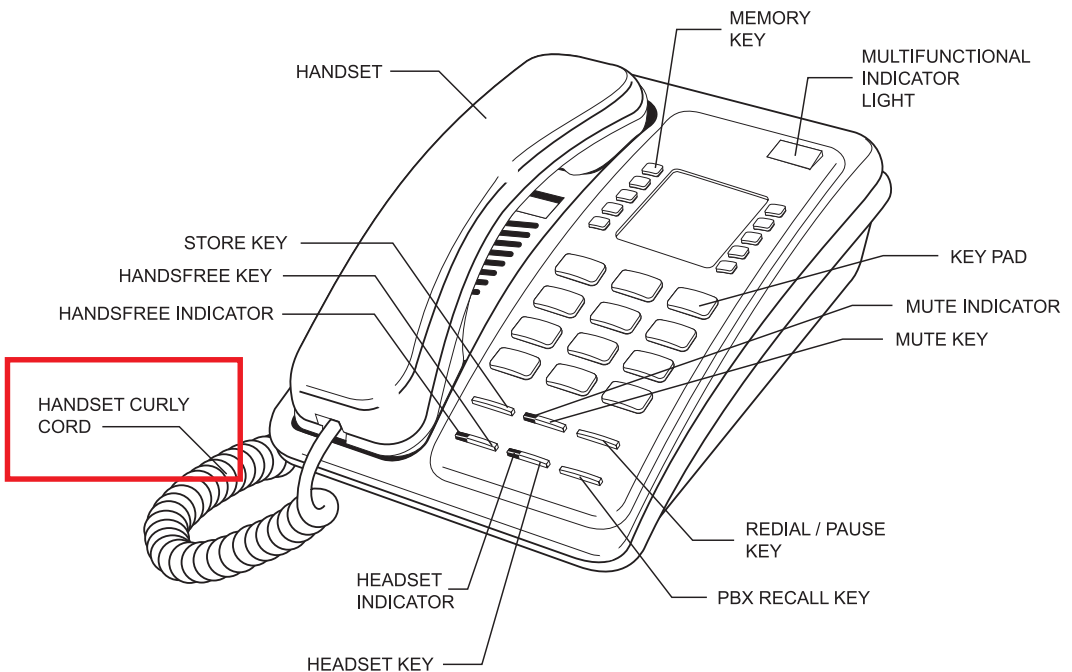

FIGURE 1 : TOP VIEW OF IQ360

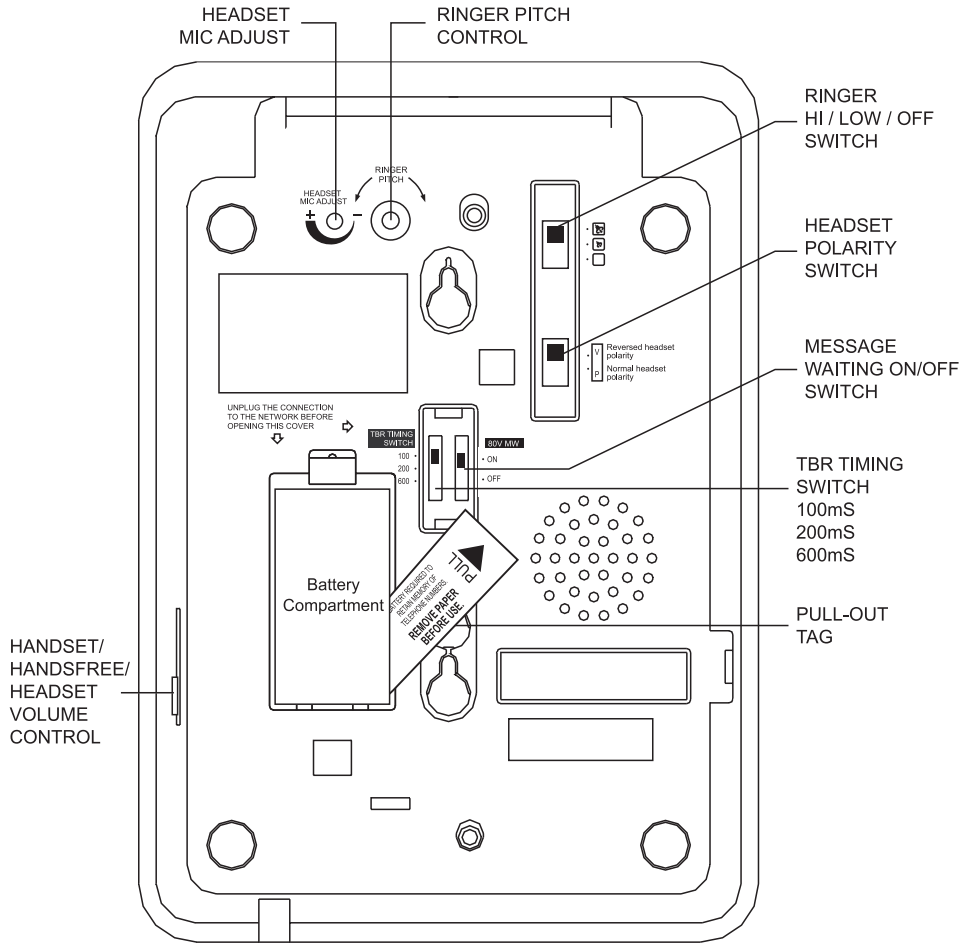

FIGURE 1 : BOTTOM VIEW OF IQ360

MULTIFUNCTIONAL INDICATOR LIGHT

There are three different functions:

Ring Indicator: Flashes when the telephone rings with an incoming call

In-Use Indicator: Glows steadily during a call

Message-Waiting Indicator: Illuminates when a message is waiting in your voicemail system (depends on system compatibility). The built-in Message Waiting option suits any neon (80 VDC) type message waiting system and also the telephone has Ericsson BP250 Message Waiting built-in (other system types are optional extras).

RINGER PITCH CONTROL

The pitch of the ringing sound may be altered by rotating the control.

RINGER VOLUME SWITCH

The three available positions allow selection of OFF (no sound), LOW volume, and HIGH volume of the telephone's ringing sound during an incoming call.

ALPHA-NUMERIC KEYPAD

The standard numeric digits are available for normal dialing. The alphabetic characters are provided to allow full access to services that require the entering of numerals and letters.

CRADLE SWITCH

Located in the handset cradle, this plastic lever is depressed by the handset (when placed in the cradle) to cut off the line. Note: Depressing this cradle lever too briefly when intending to terminate a call may result in an accidental "hookflash" that will inadvertently place the call on hold. This is known as "phantom calls" because the held call will probably ring again at your extension within a few minutes (the other party will have hung up, so it will seem as if you were called by a phantom, hence the name "phantom calls"). If you experience this problem, when terminating your call please depress the cradle lever a little longer before making/receiving your next call (i.e. it is not a system or telephone fault).

VOLUME SLIDER

Used to adjust the volume of the HANDSET, HEADSET or HANDSFREE hearing level. Set to midway for normal listening level. Adjustment during a conversation will not be detected by the other party and does not effect outgoing speech.

RECALL KEY

For use with host telephone systems to invoke special network facilities such as call-hold or call-transfer available in your system.

For further details please consult your host system manuals or user training service. Please see the INSTALLATION section for details to adjust the telephone's Flash time.

HEADSET KEY AND INDICATOR

When the HEADSET KEY is pressed a red indicator will glow to show that the HEADSET mode is activated.

HANDSFREE KEY AND INDICATOR

When the HEADSET KEY is pressed a red indicator will glow to show that the HANDSFREE mode is activated.

MUTE KEY AND INDICATOR

When pressed, it cuts off transmission from the handset, handsfree and headset microphones to allow user privacy. The red light indicates when the mute condition is active. To release the mute condition press MUTE again.

BASIC OPERATION

IQ360 can be used as a normal telephone; lift the HANDSET to answer an incoming call, or lift the HANDSET and dial on the KEYPAD to commence an outgoing call. Please refer to the appropriate sections to learn more about advanced operating instructions.

REDIAL / PAUSE KEY

Redial Function

Press to redial the last number previously dialed, which may be up to 31 digits long. It can be used in handset and headset modes. Dialing more than 31 digits during one call will cause erasure of the entire number from the redial memory.

EXAMPLE : TO REDIAL LAST NUMBER

1. Lift HANDSET, or press HEADSET or HANDSFREE
2. Press REDIAL .

PAUSE FUNCTION

The Pause command may be needed if your phone is connected to any network where a pause is required (e.g. between internal and external dial tones).

For manual dialing:

1. Lift HANDSET.
2. Dial any digits required before the pause
3. Press PAUSE
4. Dial the remaining digits.

For memory usage (storage procedure):

1. Lift HANDSET, or press HEADSET or HANDSFREE
2. Press STORE
3. Dial digits required before the pause
4. Press REDIAL/PAUSE
5. Press STORE
6. Select and press desired MEMORY key
7. Replace HANDSET or press HEADSET or HANDSFREE.

When dialed, this stored number will Pause at the appropriate place in the dialing sequence.

3. HANDSFREE OPERATION

HANDSFREE MICROPHONE

Located at the front of the phone (Figure 1), its function is to reproduce your voice as you speak to the other party while your telephone is in HANDSFREE mode. Positioning of the telephone, and therefore the MICROPHONE, is important to ensure the best reproduction of your voice.

USING THE HANDSFREE KEY

To commence a HANDSFREE call press the HANDSFREE KEY ; the telephone will activate the line, the SPEAKER, and the HANDSFREE MICROPHONE, and the INDICATOR will switch on to provide confirmation. Dialling and speech can then commence. Pressing the key again will terminate the call.

Incoming calls using HANDSFREE:

1. Telephone rings
2. Press HANDSFREE
3. Commence your HANDSFREE conversation.

Changing from HANDSFREE to HANDSET during a call:

Lift the HANDSET and resume your conversation; the HANDSFREE function will switch off automatically.

Changing from HANDSET to HANDSFREE during a call:

1. Press HANDSFREE
2. Replace HANDSET
3. Resume your conversation using the handsfree function.

Outgoing calls using HANDSFREE (manual or memory dialling):

1. Press HANDSFREE
2. Dial required number on ALPHA-NUMERIC KEYPAD or press desired MEMORY Key
3. Speak as required.

HINTS FOR HANDSFREE OPERATION

As a courtesy, tell the other party that you are using the Handsfree function. He / She may or may not want people other than yourself to hear the conversation. A quiet environment ensures best Handsfree performance. When HANDSFREE is used in a noisy room or near a noise generating device (for example, a TV set) all or part of the message may be interrupted and cannot be heard. To eliminate this problem try to lower the noise level in the room.

During the handsfree conversation, your telephone will give priority to the person who speaks louder when both people are talking simultaneously. Speak ONLY after the other person pauses or stops.

If the other person complains about poor transmission, talk directly at your telephone and from a closer distance as necessary, or lower the speaker volume control.

If the operation of the Handsfree feature is not correct, refer to the FAILURE TO OPERATE section.

4. HEADSET OPERATION

The IQ360 can be configured to suit many different headsets - please consult the INSTALLATION section for details to get the best performance from your headset.

CLARIA "ALERT" FEATURE

The IQ360 is designed to support the "Alert" feature available on the Claria headset. When pressing the HEADSET key on the telephone, the "Alert" indicator on the Claria headset will illuminate, signifying that the user is on a call. This feature can be used effectively in call center applications so that the user's colleagues will be aware that the user has a call in progress. In addition, the MULTIFUNCTIONAL INDICATOR will illuminate during the call.

BASIC OPERATION

To make or receive an outgoing call using the headset:

- Press the HEADSET Key. Dial tone will be heard in the HEADSET
- If you are making an outgoing call, dial the required number on the keypad
- Lifting the handset during headset mode will revert to handset mode operation
- To revert back to headset mode operation during handset mode, press the HEADSET Key
- To hang up, press the HEADSET key or replace the handset.

HEADSET /HANDSET/HANDSFREE MODES

A call can be moved from one mode to any other by pressing the appropriate key (Headset or Handsfree) or by lifting the Handset.

TRAINEE/SUPERVISOR MODE

Allows for the HANDSET and a HEADSET to be used in tandem. This will enable a supervisor to monitor a trainee's progress during a call, or 'take over' a call. The following procedures assume that the trainee is wearing the HEADSET and a call is in progress.

Training Mode

Allows a supervisor to monitor a trainee during a call.

1. During a trainee's call the supervisor may lift the HANDSET (HEADSET indicator will turn off)
2. Quickly press the HEADSET key and the indicator will illuminate
3. The trainee may continue the conversation with the supervisor only listening to its progress.

Supervisor Mode

Allows a supervisor to "take over" a call between a trainee and another party.

1. During a call, the supervisor may lift the HANDSET to continue a normal conversation with the other party. while the trainee listens to its progress through the HEADSET
2. To return the call to the trainee, press the HEADSET key and replace the HANDSET in the cradle.

SILENT RINGING FEATURE

Designed for Call Centers or any application where call-related noise is to be kept to a minimum, this feature allows incoming calls to ring silently; the operator is aware of the incoming call, but the telephone does not add to the room noise.

To use the telephone in Silent Ringing mode:

1. Set the RINGER VOLUME SWITCH to the OFF position (signified by the square symbol without a bell symbol inside it)
2. Put your headset on and wait for the next incoming call
3. When a call arrives, the MULTIFUNCTIONAL INDICATOR will flash and the operator will hear the ringing tone at a low level in the headset
4. Press the HEADSET key to answer the call.

5. ADVANCED NETWORK OPERATION

Where this telephone is used on an intelligent network such as Easycall, Customnet, Centel, a PABX or other network the following information may be useful.

PAUSE FUNCTION WHEN DIALLING

Depending on your telephone system, this may or may not be required. If in doubt, check with your system supplier or Interquartz dealer, as failure to observe your system's requirements may lead to difficulty in making outgoing external calls. If you have determined that a pause is required by your host system, please refer to the PAUSE Function section to ensure correct usage of the PAUSE button.

HOLDING AND TRANSFERRING CALLS

The method used for these functions is dependent on your system type, so you will need to check your system's Extension User Guide. The RECALL KEY is typically used to transfer calls. It is affected by the setting of the adjustment switches described in the INSTALLATION section of this manual. They must be correctly set to suit your system for correct operation.

USING THE MEMORIES

Many different numbers and codes can be stored. You may find it useful to store some of your favourite network facility commands in the telephone for fast, convenient access to those facilities (e.g. diversion, call forward, call back etc). Consult your system User Guide for the codes that you need to store.

6. MEMORY FEATURE OPERATION

Located at the top of the keyboard, the **ONE-TOUCH MEMORY** Keys provide easy dialing of often-used numbers. Each memory can store 15 digits and can store *, #, Pause and Recall commands.

Storing a number :

1. Lift HANDSET or press HEADSET or HANDSFREE
2. Press STORE
3. Enter the telephone number
4. Press desired memory key
5. Replace HANDSET or press HEADSET or HANDSFREE

Dialing a number :

1. Lift HANDSET or press HEADSET or HANDSFREE
2. Press desired memory key.

CASCADE DIALING

The contents of any memory can be "cascaded" or added together with additional manual dialing or other memories. In cascade dialing, make sure that each dialing sequence is completed before activating the next.

MEMORY RETENTION

The IQ360 telephone is capable of retaining its memory contents for up to 5 YEARS (battery supplied) even when the telephone line has been disconnected. To activate, remove the BATTERY PULL OUT TAG (Figure 1). The IQ360 can retain its memory contents for up to 30 minutes when unplugged from its line cord (if the battery pull out tag has not been removed).

7. INSTALLATION

UNPACKING

The carton contains the following :

- Telephone body and handset
- Coiled cord and line cord
- 2 pieces of Alkaline AA battery (Remove battery tag from battery compartment).
- This User Manual.

SETTING THE FLASH TIME

Set the TBR TIMING SWITCH to suit the PABX or host system's required flash time. This setting is needed to ensure correct operation of the Recall key on the top panel. The settings available are - 100mS, 200mS, 600mS."

GENERAL SETTING-UP

1. Fit the COILED CORD to the appropriate sockets in the HANDSET and the telephone base
2. Fit the LINE CORD to the rear socket and to your telephone network outlet
3. Remove the pull-out tag from the battery compartment by pulling gently until completely removed (see Figure 1)
4. Set the Ringer Volume and Ringer Pitch controls
5. See following sections to complete the installation.

LOCATION

The telephone should be placed on a desk, table or shelf where it is not likely to be pushed off. If the unit is to be wall mounted, it should be seated securely on the WALL MOUNTING BRACKET. Avoid excessive heat, damp, dust, direct sunlight, vibration, and other appliances or devices that may transmit or emit electrical or electromagnetic radio frequency noise or signals (e.g. computers, welders, pagers).

WALL MOUNTING

1. Fit the optional WALL MOUNT BRACKET (optional, not supplied) to the wall and attach the WALL MOUNT BRACKET to the underside of telephone (see Figure 2)
2. To enable the HANDSET to be supported in the cradle, follow the procedure shown in (Figure 2) to reverse the HANDSET RETAINER.
3. NOTE: The WALL MOUNT BRACKET and MODULAR WALL JACK illustrated in (Figure 2) are available from your authorised Interquartz dealer and can be ordered as "Wall Mount Kit No.3".

1. Use your thumb to press the HANDSET RETAINER

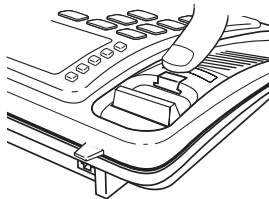

2. Push the HANDSET RETAINER out of the slot.

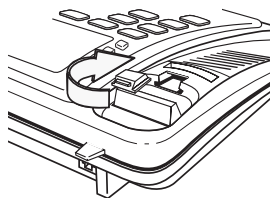
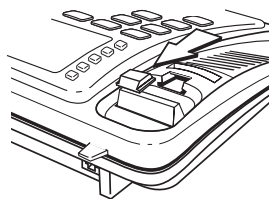

1. Rotate the HANDSET RETAINER 180°

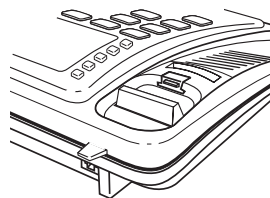

2. Insert the HANDSET RETAINER back into its slot.

FIGURE 2: WALL MOUNTING

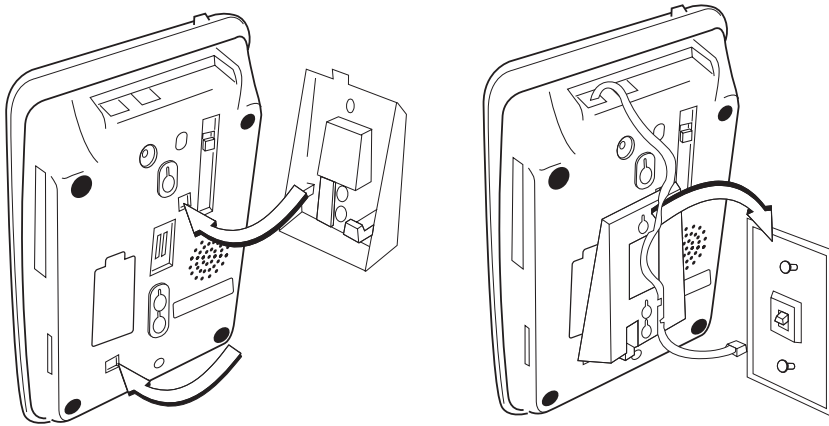
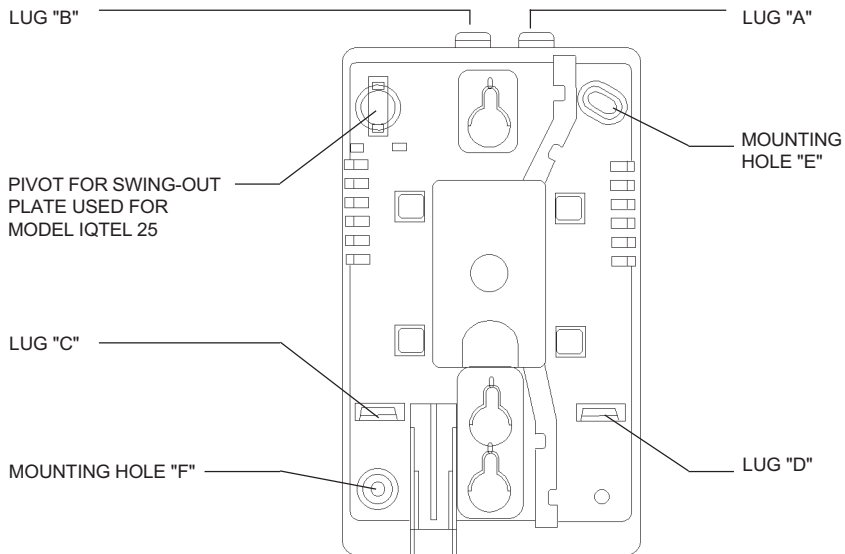

FIGURE 2 : WALL MOUNT BRACKET

WALL-MOUNT BRACKET (OPTIONAL NOT INCLUDED WITH PHONE)



Please note:

1. This wall bracket may be secured onto the wall by using mounting holes "E" and "F"
2. Lugs to break off before wall mounting the phone.

TELEPHONE MODELS		BREAK OFF LUGS
IQ 90 IQ 150 IQ 250 IQ 260 IQ 360 IQ 350 IQ 450 IQ 550 IQ E2	IQ E3 IQTEL 80 IQTEL 300 IQTEL 500 IQTEL E1 IQTEL E2 IQTEL E3 IQTEL ET STUDIO 20	"B" and "D"
IQTEL 25		"A" and "C"
IQ 300 9853 XT 9835 MKII 9836 9837		"A" ONLY

FIGURE 3

LINE CONNECTION

This telephone is supplied with a RJ45 Plug as the wall plug, with the centre pair being reserved for speech and signaling. Other types of plugs and cords are available on request.

TECHNICAL ADJUSTMENTS - FOR CORRECT OPERATION

CAUTION : Please exercise care when adjusting all selectors described, as they and their surrounding electronic components may be damaged by rough treatment. It is also recommended that all adjustments be made with the telephone disconnected from the line.

MESSAGE WAITING LIGHT COMPATIBILITY

Located in the Multifunctional Indicator Light, the Message Waiting Light can be optionally configured at time of order to be compatible with most host telephone systems on the Australian market. The standard factory fitted message waiting light is a neon style circuit suitable for minimum 80V DC signaling and is compatible with NEC, FUJITSU, ALCATEL, later HYBREX and NORTEL PABX systems. The Message Waiting Light switch is located on the telephone's underside enables or disables the light, and is factory set in the ON position.

If this telephone is configured to “message waiting” mode please note that it is only for PABX systems (contact your vendor for clarification). If so, it may not be connected to any other telephone system or network without the authority of the Australian Telecommunications Authority. For direct line use, please disable the message waiting feature using the switch on the telephone’s underside.

HEADSET MIC ADJUST CONTROL

This control allows many different headsets on the Australian market to function correctly with the IQ 360 telephone by adjusting the HEADSET’S Microphone sensitivity . The control is located on the underside of the telephone. The adjustment can be made by a small screwdriver or similar implement that will fit into the control slot. Please see (Table 1) as a guide to the correct settings for most popular headsets.

To make a headset mic level adjustment :

With the headset connected as per the instructions in this manual:

1. Put the headset on and lift the HANDSET to your other ear and make an out-going call
2. Pressing the HEADSET key, swap between HANDSET and HEADSET mode (The indicator will illuminate when the HEADSET is in use) a few times while speaking to the other party
3. With the other party's help decide if your voice level is the same when using the HANDSET and HEADSET.

If you sound too loud on the headset, adjust the microphone sensitivity (turn anti-clockwise) so that your voice level when using the HEADSET matches that of the HANDSET. Clockwise rotation increases the HEADSET mic output level. Please see (Table 1) as a guide to the correct settings for most popular headsets.

HEADSET POLARITY SWITCH

Located on the underside of the telephone, this switch provides compatibility with the two commonly-used headset wiring standards.

Position 'V' suits Plantronics Vista Cords and other Headsets wired in the same configuration (also known as "reversed" wiring mode).

Position 'P' suits Plantronics P cords and other Headsets wired in the same configuration (also known as "normal" wiring mode).

Please see (Table 1) as a guide to the correct settings for most popular headsets.

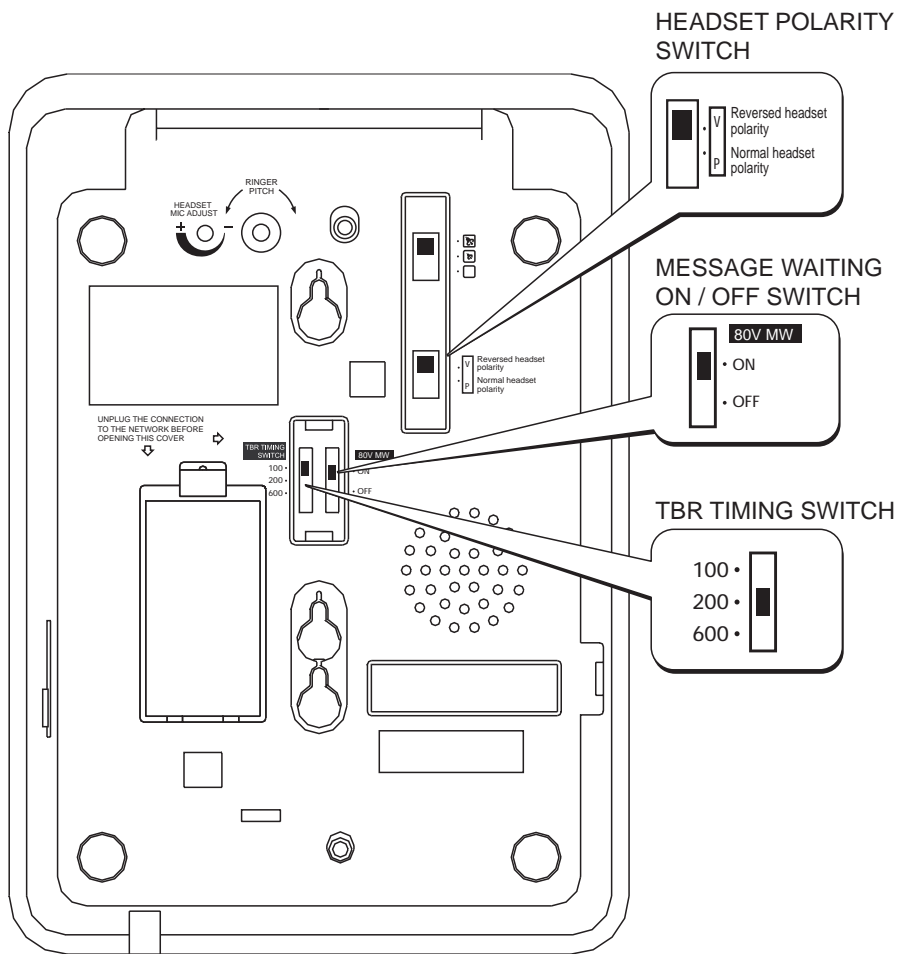





















FIGURE 4

Headset Model	Headset Mic Adjustment Control	Headset Polarity Switch
ACS Orator	 50%	P
ACS stratos	 50%	P
Addcom Elite	 100%	P
Addcom Contour	 100%	P
BTC GHA-M201	 100%	P
BTC GHA M201N	 100%	P
Claria	 100%	P
Claria Alert	 100%	P
Crest II	 100%	P
GN Netcom Profile III Flex	 75%	P
GN Netcom Optima	 100%	P
GN Netcom Advantage	 100%	P
GN Netcom Shades	 100%	P
Plantronics H series with V cord	 100%	V
Plantronics P series with P cord	 100%	P
THW LS1-A	 100%	P
THW Crown	 100%	P
Unex Flexpro F100 NTN	 100%	P
Unex Flexpro F200 NTN	 100%	P
Please Note: Information above applies to headsets with cord, supplied for use without an amplifier.		

Explanation of Headset Mic Adjustment control settings in table:





-  100% = Fully Clockwise (loudest mic setting).
-  100% = Fully Anti-Clockwise (softest mic setting).
-  50% = Halfway (mid mic level)
-  75% = Three quarters Clockwise (loud mic level)

TABLE 1

8. GENERAL CARE AND MAINTENANCE

This telephone is a precision electronic instrument. While in use and storage, care should be taken to avoid rough handling, extreme temperature, and damp or dirty environments.

CLEANING

NEVER use aerosol sprays or other chemical agents or substances that leaves a residue (furniture polish for example).

Use a mild detergent and a damp, clean cloth when cleaning. Do not allow moisture to enter the telephone's interior - damage may result!

FAILURE TO OPERATE AND SERVICE DIFFICULTIES

If telephone service problems occur at any time, it is recommended that the installation procedure described in this manual be re-checked.

If a fault occurs, try to determine if the fault is with the telephone, or with the network or system to which the telephone is connected:

Disconnect the "suspect" telephone, and test the line with a substitute telephone. If the telephone service then operates satisfactorily, the fault is in the "suspect" telephone.

Test the "suspect" telephone on a known good line. If the fault still occurs, the fault is in the "suspect" telephone.

Consult your Interquartz dealer for further advice if necessary.

9. THUNDERSTORMS

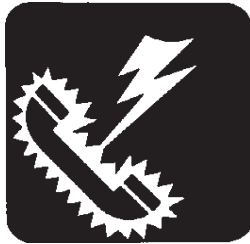

The telephone, in common with household electrical appliances, can be a source of electric and acoustic shock during thunderstorms. The possibility of a telephone user experiencing a shock is minimal. Nevertheless, customers should be aware of some simple precautions to follow during thunderstorms:

Use your telephone only for calls of the utmost urgency. Keep these calls brief.

Whilst using your telephone keep clear of electrical appliances and metal fixtures such as : stoves, air conditioners, refrigerators, window frames and sinks.

10. WARRANTY - 6 YEARS

Interquartz (A'Asia) Pty Ltd warrants the original purchaser against failure, under normal usage and in the environment and network for which it was designed, resulting from defective material and workmanship at time of manufacture for a period of SIX YEARS from the date of purchase. Proof of purchase and date of purchase are required for determining validity of this warranty. This warranty does not cover defects or damage due to normal wear and tear, negligence, accidents, exposure to radiation, misuse, obsolescence, incompatibility, improper maintenance, lightning strikes or unauthorised repairs or modifications and excludes freight or postage costs to/from your local authorised service centre unless otherwise arranged. Consequential loss not included. Notification of any defect must be made within the warranty period before a warranty repair can be effected. This guarantee is in addition to all other Warranties or Guarantees expressed or implied by the Trade Practices Act or other Commonwealth or State laws and all other obligations and liabilities on the part of Interquartz (A'Asia) Pty. Ltd.

11. SERVICE CENTRES

VICTORIA	03-9464-3333
NEW SOUTH WALES	02-9875-4011
QUEENSLAND	07-3252-2255
SOUTH AUSTRALIA	1800 6 IQTEL
WESTERN AUSTRALIA	1800 6 IQTEL
TASMANIA	1800 6 IQTEL

Manufactured by
International Quartz Limited

A Subsidiary of Chiaphua Industries Ltd.

©Copyright INTERNATIONAL QUARTZ LTD. 2002

3C9393013-03